

Calcified Vessel Model Capstone Project

Conceptual Design Report

James Anteau, Test Engineer

Gavin Lazurek, Logistics Manager

Jamie Dellwardt, Project & Financial Manager

Scott Alex, Manufacturing & CAD Engineer

Fall 2024-Spring 2025



Project Sponsor: W.L. Gore & Associates, Inc.

Sponsor Mentor: Anthony El-Shamsi, Cameron Fisher, DJ Mongeau

Instructor: David Willy

DISCLAIMER

This report was prepared by students as part of a university course requirement. While considerable effort has been put into the project, it is not the work of licensed engineers and has not undergone the extensive verification that is common in the profession. The information, data, conclusions, and content of this report should not be relied on or utilized without thorough independent testing and verification. University faculty members may have been associated with this project as advisors, sponsors, or course instructors, but as such they are not responsible for the accuracy of results or conclusions.

EXECUTIVE SUMMARY

The Calcified Vessel Model is a mechanical engineering capstone project that has been proposed by W.L. Gore & Associates Inc. – Medical and facilitated by Northern Arizona University – College of Engineering, Informatics, and Applied Sciences, for the Fall 2024 and Spring 2025 semesters. The primary objective for the capstone project is to design, build, and test 12 replicable models of calcified lesions within the peripheral arterial system for the purpose of testing peripheral vascular interventional devices intended for the treatment of peripheral artery disease (PAD). The team's goal is to produce these calcified vessel models to mimic real-life anatomical and pathological characteristics of PAD in affected blood vessels, ensuring accurate and effective testing for device deployment. The client stipulated that this goal must be accomplished using only non-biological materials. By utilizing non-biological, three-dimensional printed models, the project addresses cost and reproducibility in device testing and enables better development and delivery of devices for clinical applications. Furthermore, these models could be used as teaching tools for both researchers and medical teams working in vascular interventions.

In the current state of the project, the team has employed several concept evaluation techniques to develop an initial design concept that will be explained thoroughly in this report. The initial design consists of the following sub-systems: the artery model, lesion model, pump system, blood analog, and platform for holding of the model.

The artery model will mimic the shape of the femoral artery, as many cases of PAD occur in this section of the arterial system, and because it makes for an effective testing model due to its large diameter. The artery model will be manufactured by stereolithography (SLA) 3D printing using a semi-translucent flexible resin selected for its similar properties to those of a femoral artery. The lesion models will be manufactured by fused deposition modeling (FDM) 3D printing using a high-hardness filament selected for its similar properties similar to those of a calcified lesion. The geometry of these lesion models will vary over the 12 models created to allow for vascular interventional devices to be tested on a wide range of disease states. The pump system contains three further subsystems, as the pump system has several functions. The first of these subsystems is the pump itself. The pump chosen by the team was selected by calculating the power required to achieve the correct properties of blood flow under simulated use conditions. A peristaltic pump that meets these criteria was selected for this purpose. The next of the pump subsystems is the computing and sensing unit. To allow for precise data collection when testing the model, the team will employ pressure transducers at the inlet and exit of the artery model. The data collected by the sensors will be transmitted to and processed by an Arduino module, then printed to an LCD screen for the operator(s) of the model to see. The final pump subsystem is the power supply for the pump. A variable power supply will be used for this purpose. The blood analog that will be pumped through the model must have a similar density and viscosity to real human blood. Following a literature review, the team identified a certain solution of corn syrup, water, and flour which can be used to accurately model properties of human blood well enough for the prototyping phase of the design process. The team will test different ratios of the ingredients until the relevant properties of the mixture are within an acceptable range. All subsystems will be contained within a trolley or medical cart that the team will purchase. The artery model will sit on the top of the cart. The pump, computing and sensing unit, and power supply will be mounted on the underside of the top shelf of the cart. The blood analog will be held in a tank that sits on the bottom shelf of the cart.

The next step for the team is to continue with iterations of prototyping and testing the subsystems listed above to ensure they meet the success metrics of this capstone project. For upcoming final deliverables within their Mechanical Engineering Design class, the team is looking towards building their final two subfunction prototypes and testing them. To meet these requirements, the team has purchased all their necessary products and will use those products to prototype and test the sensing and computing unit, the blood analog, the artery and lesion model, and the pump system, regarding their specific customer and engineering requirements.

TABLE OF CONTENTS

Contents

DISCLAIMER	1
EXECUTIVE SUMMARY	2
TABLE OF CONTENTS	3
1 BACKGROUND	1
1.1 Project Description	1
1.2 Deliverables	1
1.3 Success Metrics	1
2 REQUIREMENTS	3
2.1 Customer Requirements (CRs)	3
2.2 Engineering Requirements (ERs)	3
2.3 House of Quality (HoQ)	5
3 Research Within Your Design Space	6
3.1 Benchmarking	6
3.2 Literature Review	8
3.2.1 James Anteau	8
3.2.2 Gavin Lazurek	10
3.2.3 Jamie Dellwardt	12
3.2.4 Scott Alex	14
3.3 Mathematical Modeling	16
3.3.1 Pump Power- James Anteau	16
3.3.2 Calcified Lesions - Gavin Lazurek	16
3.3.3 Cost Analysis - Jamie Dellwardt	17
3.3.4 Filament Usage – Jamie Dellwardt	19
3.3.5 Wall Shear Stress – Scott Alex	20
4 Design Concepts	21
4.1 Functional Decomposition	21
4.2 Concept Generation	23
4.2.1 Top-Level Design	23
4.2.2 Calcified Lesion Material	25
4.2.3 Calcified Lesion Adhesion Method	26
4.2.4 Blood Analog	28
4.2.5 Blood Vessel Design	30
4.3 Selection Criteria	33
4.3.1 Top-Level Design	33
4.3.2 Calcified Lesion Material	33
4.3.3 Calcified Lesion Adhesion Method	34
4.3.4 Blood Analog	35
4.3.5 Blood Vessel Design	35
4.4 Concept Selection	36
4.4.1 Top-Level Design	36
4.4.2 Calcified Lesion Material	36
4.4.3 Calcified Lesion Adhesion Method	37
4.4.4 Blood Analog	38
4.4.5 Blood Vessel Design	39
4.4.6 Final Design CAD and Flow Diagram	41
5 Schedule and Budget	43
5.1 Schedule	43

5.2	Budget.....	45
5.3	Bill of Materials (BoM).....	46
6	Design Validation and Initial Prototyping	47
6.1	Failure Modes and Effects Analysis (FMEA)	47
6.2	Initial Prototyping.....	49
6.2.1	Vessel/Lesion Prototype.....	49
6.2.2	Arduino/Sensor Prototype.....	51
6.3	Other Engineering Calculations.....	52
6.3.1	Blood Analog Recipe (James Anteau)	52
6.3.2	SLA Resin Material Properties (Gavin Lazurek).....	55
6.3.3	Data Uncertainty and Flow Rate Analysis (Jamie Dellwardt)	57
6.3.4	Differential Pressure – Internal Vessel Pressure Drop (Scott Alex).....	58
6.4	Future Testing Potential.....	60
6.4.1	Calcified Lesion Dimensions.....	60
6.4.2	Calcified Lesion Properties.....	60
6.4.3	Blood Analog Properties.....	60
6.4.4	Calcified Vessel Dimensions.....	61
6.4.5	Calcified Vessel Properties	61
7	CONCLUSIONS	62
8	REFERENCES	63

1 BACKGROUND

This section of the report contains three subsections aimed at enhancing the understanding of the background belonging to this capstone project. *Project Description* is a top-level description of the project summarized from the given project outline and meetings the team had with their client. *Deliverables* is a description of the major deliverables, including those of the course and the client. *Success Metrics* is a definition of how the success of the project will be assessed, referencing testing, calculations, and major design requirements.

1.1 Project Description

The calcified vessel model capstone project concerns the designing, building, and testing of 12 replicable models of calcified lesions in the Peripheral Arterial System, using non-biological materials. These models will replicate the conditions under which vascular interventional devices are deployed, offering a precise platform for testing device performance under simulated use conditions. The goal is to create models that mimic real-life anatomical and pathological characteristics, ensuring accurate testing for device development. Peripheral arterial disease (PAD) affects millions globally, often leading to severe complications if untreated. Vascular interventional devices are critical in treating PAD by restoring blood flow and reducing symptoms. This project seeks to enhance the development of these devices by providing affordable and reproducible testing models, facilitating research and design optimization. The project's most significant expenses will be for materials needed to create and test the prototypes. Fundraising efforts include approaching local businesses, launching a GoFundMe campaign, and seeking partnerships with companies or research labs that could benefit from or contribute to the project. These efforts aim to ensure adequate financial backing for the successful production of the calcified vessel models and their associated testing requirements.

1.2 Deliverables

The calcified vessel model capstone project requires that the team meet several deliverables by the end of the project life cycle. The first of those deliverables is a detailed literature review of all credible sources used by the team in their research for this project. A project proposal is to be submitted at the end of the first semester for the client to review and approve the team's proposed design. Furthermore, a final report is to be submitted at the end of the second semester for the client to review the entire body of work the team has produced for this project. All engineering analyses the team performed on relevant technical aspects of the design are to be submitted. A cost estimate to duplicate the entire calcified vessel model is to be submitted, as well as a bill of materials featuring each component used in the design. If applicable, a drawing package and software files are to be submitted, as well. A detailed procedure for repeatable manufacturing of the calcified vessel model is expected to be written and submitted. Receipts of all product purchases and team expenses are expected. 12 functional models for testing in addition to the original calcified vessel model are to be submitted. Finally, the team will be invited to the offices of Gore & Associates – Medical to present the team's model in-person to the client.

1.3 Success Metrics

In the effort to design, build, and test a replicable model of calcified lesions in the peripheral arterial system for deployment of peripheral vascular intervention devices under simulated use conditions, using non-biological materials, the team has several success metrics with which to judge the overall success of their model. The first such metric of this project is safety. The model must adhere to all relevant safety standards as defined by ANSI, OSHA, or other applicable organizations. The model will also be judged by its ability to develop, justify, and characterize a variety of attributes of the calcified

lesions present in PAD. These attributes include, but are not limited to, the durometer, adhesion strength, length, thickness, and degree of vessel occlusion. Accurate modeling of these attributes is crucial to the overall effectiveness of the calcified vessel model as a test instrument for peripheral vascular intervention devices. The model will also be judged by its ability to allow visualization of peripheral vascular intervention device deployment. To be an effective model for testing of intervention devices, the operators of this model should be able to see and understand its inner workings as a device interacts with the calcified vessel model. The model will also be judged on the replicability of its manufacturing processes. Because this calcified vessel model is intended for mass-production, the ability to effectively repeat the manufacturing processes involved in its production is crucial to its success. The team should be able to compose a document of these repeatable manufacturing processes that the client is able to follow exactly. Finally, the model will be considered a success if it does not exceed its allotted budget of \$3000 provided by the client. The team will likely fundraise an additional 10% of the original budget to contribute towards the project.

Above all, the calcified vessel model capstone project will be considered a success if it upholds the standards of W.L. Gore & Associates products, which are designed to be of the highest quality in their class and revolutionary in their effect. As a product, the model should live up to all its promises and address this given technical challenge with an innovative, reliable solution. Further definition of project success metrics is provided in Section 2, as well as in the mathematical modeling of Section 3.3.3, and the selection criteria of Section 4.3.3. Additional success metrics for the model may be developed in the future, especially as the team enters the final design phase of the project.

2 REQUIREMENTS

This section of the report contains three subsections to show and explain the quality function deployment (QFD) of this capstone project. The purpose of the QFD is to relate the customer requirements (CRs) to quantifiable engineering requirements (ERs) that will be used to inform the team when making design decisions. The QFD is done via the deployment of a house of quality (HoQ). Within the HoQ exists two rooms; one room shows the correlation between the customer requirements and the engineering requirements, while the other weighs the engineering requirements against each other. The result of a successful QFD is a filled-out HoQ that the team can use when comparing concepts generated in Section 4 of this report. The rest of this section is comprised of three subsections which list and define the requirements mentioned previously and display the completed HoQ of this project.

2.1 Customer Requirements (CRs)

The customer requirements for this project come directly from the client of this capstone project, the W.L. Gore & Associates medical division. The customer requirements list was derived from the initial capstone project outline and from the team's initial client meeting with sponsor mentors.

- Replicability – The calcified vessel model must be easily replicated by purchasing, manufacturing, and assembly procedures available to the client, so that more models can be produced if they are deemed useful in testing endoprosthesis medical devices used in treating peripheral arterial disease (PAD).
- Models simulated use conditions – The calcified vessel model must accurately simulate real-world use conditions for the endoprosthesis medical devices intended to be tested on the model. This requires simulating the conditions of the peripheral arterial system as well as the calcified lesion(s) within that system.
- Non-biological materials – The calcified vessel model must be made entirely from non-biological materials to avoid any additional safety and sanitation risks before, during, and after use.
- OSHA/ANSI Compliance – The model must be safe to manufacture and operate.
- Visualization of deployment – The operator(s) of this calcified vessel model must be able to visualize the deployment of the medical devices undergoing testing on the model, which are used in treatment of PAD.
- Durability – The calcified vessel model should be designed in such a way that it can withstand multiple usage cycles before becoming ineffective for its intended use.
- Ergonomic for intended use – The calcified vessel model must be of a size and shape that allows for the client to use for demonstrative and testing purposes.

2.2 Engineering Requirements (ERs)

The engineering requirements for this project were developed by the team to create quantifiable targets that help inform the team when making decisions about the design of the model.

- Vessel properties – The vessel properties include the pressure within the vessel and opacity of the vessel model. The target for pressure within the vessel is 11-17 kPa, and the target for opacity is >50%. This will ensure the vessel has the correct blood pressure and the operator will be able to see the deployment of the vascular interventional devices.
- Vessel dimensions - The dimensions of the vessel must be accurate to the dimensions of the

vessel in the body that the stent is designed to be deployed in, as well as accommodate for the stent in its entirety. The targets for this are a length of ~30 cm, a wall thickness of 1-2 mm, and a diameter of 8-9 mm.

- Lesion properties – The properties important to accurate calcified lesion modeling are the indentation hardness and adhesive strength to the vessel wall. The target property values are ~39 on the Shore D scale for hardness, and >27 pascals for adhesive (shear) strength. These values were determined through research and analysis of real-world calcified lesion properties performed by the team (see section 4.3.2 and 4.3.3). Achieving these target values for calcified lesion properties will create a more accurate and useful calcified vessel model.
- Lesion dimensions – The dimensions important to accurate calcified lesion modeling are the length, thickness, and degree of vessel occlusion. The target dimension values are 5 mm for length, 0.5 mm for thickness, and 50% for degree of vessel occlusion. These values were determined through research and analysis of real-world calcified lesion dimensions performed by the team (see section 3.3.2). Achieving these target values for calcified lesion dimensions will create a more accurate and useful calcified vessel model.
- Fluid properties – The blood analog that runs through the artery model must have similar properties to the blood within a patient being treated for this disease. The target values for the fluid properties came from the team's research. The properties measured are flow rate, dynamic viscosity, density, and temperature. The targets for these properties are a flow rate of 400 mL/min, a dynamic viscosity of 0.006 Pa*s, a density of 1060 kg/m³, and a temperature of 37°C.
- Engineering standard compliance – The engineering standard compliance will be measured by a % deviation from the standards used by the team. The target for this is a 0% deviation, or a 100% compliance, to the applicable standards.
- Manufacturing cost – The cost of manufacturing the overall calcified vessel model and 12 replicable artery models must stay within the \$3,000 budget provided by the client. That budget has increased to \$3,800 as the team has done additional fundraising.

2.3 House of Quality (HoQ)

Vessel Properties													
Vessel Dimensions													
Lesion Dimensions			9										
Lesion Properties		3	3	6									
Fluid Properties		3	3		1								
Engineering Standard Compliance													
Manufacturing Cost		-3	-3	-1	-1	-1	6						
		Technical Requirements						Customer Opinion Survey					
Customer Needs	Customer Weights	Vessel Properties	Vessel Dimensions	Lesion Dimensions	Lesion Properties	Fluid Properties	Engineering Standard Compliance	Manufacturing Cost	1 <i>Poor</i>	2	3 <i>Acceptable</i>	4	5 <i>Excellent</i>
Replicability	4						9	9	A		C		B
Models simulated use conditions	5	9	9	9	9	9				A		BC	
Non-biological materials	3	9			9	9			A				BC
OSHA/ANSI standard	4						9	6				A	BC
Visualization of deployment	4	3			3	6				A			BC
Durability	2	6	3	3	6			3				ABC	
Ergonomic for intended use	2		6	6				3					ABC
Technical Requirement Units		Pressure (kPa) Opacity (%)	Length (cm) Thickness (mm) Diameter(mm)	Length (mm) Thickness (mm) Degree of Vessel Occlusion (%)	Strength (Pa) Durometer (HS)	Flow rate (mL/s) Dynamic viscosity (Pa*s) Density (kg/m ³) Temperature(K)	%	USD					
Technical Requirement Targets		11-17 kPa 50%	~30 cm 1-2 mm 5-9 mm	5 mm 0.5 mm 50%	27 Pa Shore 39D	7-2 mL/s 0.003-0.006 Pa*s 1060 kg/m ³ 310 K	100%	\$3000 USD					
		Legend											
		A Creative Biolabs 3D Biology											
		B Preclinic Medical Simulation											
		C Vivitro Labs - Simulators											

Figure 1 – HoQ deployed for QFD

3 Research Within Your Design Space

This section of the report contains three subsections which aim to provide deep insights into the research performed by the team which aided them in their understanding of the capstone project and influenced their future work. Section 3.1 identifies and describes three state-of-the-art systems within this design space on the system level, as well as all other subsystem-level benchmarking used. Section 3.2 is an annotated bibliography of references used for this project, providing a brief description of each reference and how it applies to this project. Section 3.3 is a summary of the equations, engineering tools, and examples used by the team for the design of the project's subsystems.

3.1 Benchmarking

Numerous existing designs of medical testing models aim to accurately simulate aspects of the human body. In this section, there are three designs from three different companies that were analyzed to gain insight into the engineering and applications of artificial vessels and calcified lesions. Each company is currently active in the market and has made their product information available to the public. These companies mainly gain interest from the medical field, and their products have evolved over time to enhance their functionality to these customers. From the team's benchmarking research, it is apparent that all three companies/products share the same goal: to create a product that improves patient outcomes as well as enhance the skills, expertise, and knowledge of surgeons and practitioners.

All research for this section was done through literature review of credible website sources, focused on human body blood vessel simulation models. Through searching, the team was able to find the following three manufacturers with vessel simulation designs that mimic the human body. Each manufacturer provided websites that included their product, their services, and their company purpose. Through this initial benchmarking research, the team gained a clearer understanding of what would go into the design of their client's product. This research gave the team a direction to take their project in. However, the team must conduct this project with a budget in mind, so their design would have to conform strictly to their specific customer needs over other optional considerations.

These three manufactured products operate with one goal: to simulate human blood flow within the desired vessel site to deploy interventional devices. The overview of accurately replicating the human body offers significant benefits for the public. Surgeons and practitioners can use these life-like vessel simulation models to practice stent applications for use on real patients. These products can enhance surgeons' and practitioners' skills in operating medical devices within a diseased vessel, and thus offer patients better medical care. Testing medical devices within these vessel models provides information and data that would be useful for real surgeries.

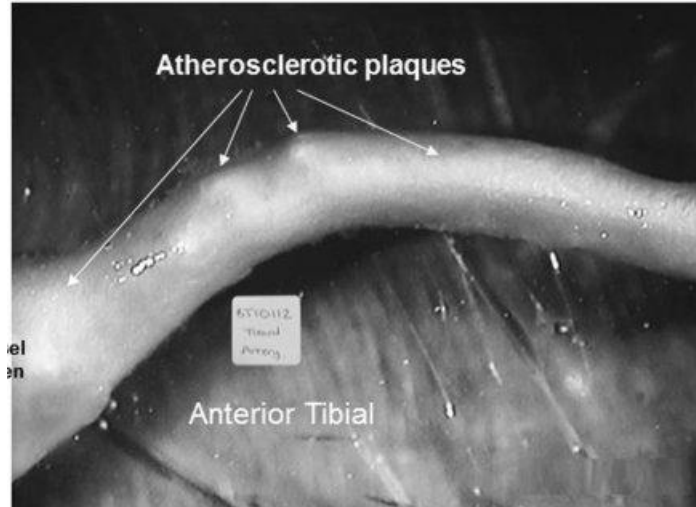

Figure 2 - Atherosclerotic tissue sample [46]

Creative Biolabs 3D Biology [46]

Creative Biolabs is a biotechnology company known for providing specialized services and products. They focus their manufacturing on the 3D biology field, which is crucial for understanding diseases within the human body and the drug intervention exploration for treating these diseases. Creative Biolabs primarily develops 3D biological models that simulate biological functions in the human body. Figure 2 shows an example of the company's biological model work. It illustrates a biological model of an anterior tibial vessel, featuring atherosclerotic plaque embedded within its interior. This benchmark source will serve as a reference for the team in designing and optimizing the overall setup of the simulation. Primarily the simulated fluid system the company utilizes. This is important for use in research, drug intervention developments, and medical device testing. Creative Biolabs' 3D models are more realistic testing platforms compared to non-biological models.



Figure 3 - Silicon Cardiac Vessel Model [44]

Preclinic Medical Simulation [44]

Preclinic Medical Simulation is a manufacturer that specializes in medical simulation models for utilization by medical personnel for training purposes, research, and testing medical devices. This

manufacturer does an exceptional job at developing accurate and functionally realistic models that replicate human vessel sites and physiological conditions. Figure 3 presents a great example of the company's work and expertise. Manufactured out of silicone and designed for medical testing, this cardiac vessel simulation model exemplifies the company's ability to produce highly accurate replicas designed to the precise dimensions of human vessels. The team plans to utilize this benchmark, drawing insights from its dimensional accuracy to inform the development of models that closely align with human anatomy. This model offers an alternative to using animals for testing medical devices, as no biological material is used in this manufacturer's models. All models are composed of silicone material, which are synthetic polymers made of silicon and oxygen also known as Polysiloxane.



Figure 4 - Endovascular Simulator [33]

Vitro Labs – Simulators [33]

Vitro Labs is a manufacturer that specializes in designing and developing advanced cardiovascular testing equipment and simulators used for research, medical testing, and development of intervention devices for cardiovascular diseases. Vitro Labs focuses on providing precise simulation and testing solutions that replicate the human vessel and arteries along with the physiological conditions of the human body. The process flow of these designs simulates and replicates the dynamic conditions of the heart and vascular system. This allows for realistic testing of medical devices in a controlled setting. Figure 4 features the endovascular simulator, one of the many innovative products offered by the company. This simulation model is designed to provide everything necessary for accurate data recording and medical simulation testing. It includes a vessel model, a pulsatile pump that replicates heart cadence, a data acquisition system, and a manifold for interchangeable vessel models. This benchmark will be invaluable to the team, serving as a reference for establishing standards for the overall system design and development.

3.2 Literature Review

3.2.1 James Anteau

Viabahn stent instruction manual [47]

An instruction manual from the Gore website that outlines the deployment procedure for their Viabahn stent. This source is created and owned by the client and sponsor for this project. It explains the

procedure for use of the stent. It provides crucial information that will inform the design of the inlet port for the stent, as well as the overall dimensions of the model.

Harrison's Principles of Internal Medicine, 21st edition [48]

A medical textbook that contains a chapter on peripheral arterial disease. The chapter discusses the cause, diagnosis, and treatment of this disease. It provides valuable background information about PAD which will help aid the team in preliminary design of the lesions and arteries.

Comparison of BARD®LIFESTREAM™ covered balloon-expandable stent versus GORE® VIABAHN™ covered self-expandable stent in treatment of aortoiliac obstructive disease: study protocol for a prospective randomized controlled trial (NEONATAL trial) [49]

A medical scholarly journal article aimed at providing a comparison of two stents that would potentially be used within the team's final model. It discusses in depth the common failures of both stents as well as their advantages. This will inform the team on how to create lesions or conditions that will prove useful in testing the stents and their failure behaviors.

Endovascular Today: Stent device guide [50]

This website contains a spreadsheet of several different intravenous stents from different medical companies. It contains the dimensions and properties of the stents in a spec sheet format. This will provide the team with information that will dictate the dimensions of the artery model, and the inlet for the stents.

A computational study of effects of material properties, strain level, and friction coefficient on smart stent behavior and peripheral artery performance during the interaction process [51]

This scholarly journal article contains a computational study of the effects from the interaction between a smart stent and the wall of the artery vessel. As the title states, the article outlines the material properties, strain, and friction coefficient developed when the interaction occurs. This information will inform the team's decisions for material and design of the artery model.

W. L. GORE & ASSOCIATES ENHANCES GORE® VIABAHN® ENDOPROSTHESIS PORTFOLIO WITH LOWER PROFILE DELIVERY [52]

Press release for an improvement to the Gore Viabahn design. This shows the different dimensions and properties of their improved design. This source further deepens the team's knowledge on the devices that will be used within the model. This furthers the informing for design decisions.

OSHA Regulations [53]

Provides information on how to keep the project safe when creating and testing the model. As one of the customer requirements for this project is compliance with ANSI and OSHA standards, the team must review any pertinent codes or standards for this project.

IPC J-STD-001 H Standard Soldering Requirements. [72]

This article outlines industry standards for electronic soldering. The actual copy of this standard costs over 200 dollars which exceeds what the team is willing to use from the budget. This article does a great job of outlining the key points of the standard so that the team can ensure that the soldering used in the project will be up to industry standards.

Blood Rheology: Key Parameters, Impact on Blood Flow, Role in Sickle Cell Disease and Effects of Exercise [73]

This scholarly journal article outlines how sickle cell disease effects the blood flow within the body. While the main topic of the paper does not apply to this project, the paper discusses the typical parameters of blood viscosity in the human body. This range of viscosity will serve as the team's acceptable range when deciding upon a blood analog for the model.

“Human Blood - an overview | ScienceDirect Topics [74]

This article from science direct provides the team with valuable insight into the properties of blood. It explains how dynamic of a fluid blood is, and what acceptable blood analogs look like as far as their properties. This informed the team heavily when creating the blood analog for the project.

3.2.2 Gavin Lazurek

Materials Science and Engineering: An Introduction, 10th Edition [13]

A textbook on the subject of general and introductory materials science. It explains the primary types of materials: metals, ceramics, polymers, and composites, as well as the relationships between material structural elements and their properties. It will help guide the team in characterizing and calculating peripheral arterial calcification material properties, such as durometer and adhesion strength, which are essential requirements of the project. Furthermore, the textbook may also provide useful information on 3D printing to manufacture calcified lesion models with desired material properties.

Schaum's Outline of Probability and Statistics, 4th Edition [14]

A textbook on the subject of probability and statistics. It explains the fundamentals of conditional probability and independence, random variables, binominal and normal distributions, sampling distributions, and analysis of variance. It will provide statistical tools for the analysis of medical experiments and the relevant data they provide to designing calcified vessel models. For this project, it will be used to determine statistical significance of results from medical experiments regarding angioplasty procedures on peripheral arterial calcifications.

GORE® VIABAHN® Endoprosthesis [15]

A website from the W.L. Gore & Associates, Inc. medical division about their company’s medical device product: the Viabahn endoprosthesis medical device. This source belongs to the sponsor of this team’s capstone project, and they intend to use the team’s calcified vessel model for testing of their Viabahn endoprosthesis. It provides information, instructions, clinical uses, case studies, specifications, and further reading related to Gore Medical's Viabahn stent. This source provides an in-depth view of the Viabahn stent, aiding the team in their understanding of the simulated use conditions which the calcified vessel model should be able to replicate.

A new optical coherence tomography-based calcium scoring system to predict stent underexpansion [16]

A scholarly journal article published in the peer-reviewed medical journal EuroIntervention. It is a retrospective observational study which compares several properties of peripheral arterial calcifications to the results of angioplasty procedures performed on those calcifications. The study uses blood vessel imaging technology to ascertain precise dimensions of calcifications. Then based on its results, the study proposes a mathematical model which can accurately predict stent underexpansion based on peripheral arterial calcification properties. It reveals which factors related to blood vessel calcification interfere with stent expansion and reveals the critical values at which stent underexpansion becomes likely. This source will help the team make decisions about the dimensions of modeled calcified plaque for effective usage of their calcified vessel model for endoprosthesis testing.

Carotid Artery Stenting for Calcified Lesions [17]

A scholarly journal article published in the official open-access journal Stroke: Vascular and Interventional Neurology of the American Heart Association and the Society of Vascular and Interventional Neurology. It is a correlation study comparing the arc of circumferential vessel occlusion in patients with peripheral arterial calcification to the outcomes of balloon expansions in stent placement operations. It reveals a statistical correlation between degree of vessel occlusion and residual stenosis, providing guidelines for necessary balloon expansion pressure during stent placements depending on

calcification levels. This source will assist the team in understanding the common characteristics of heavily calcified arterial plaque and the outward radial pressure they must withstand during angioplasty procedures, which will influence the design of the calcified vessel model.

Quantifying Effects of Plaque Structure and Material Properties on Stress Distributions in Human Atherosclerotic Plaques Using 3D FSI Models [18]

A scholarly journal article published in the Journal of Biomechanical Engineering of the American Society of Mechanical Engineers. It is a computational study that utilizes blood vessel imaging technology to create 3D structural and fluid models of peripheral arterial calcification for mechanical analysis. It provides mathematical relationships of stress and strain levels in calcified lesions according to calcified plaque material properties and geometries. This source will help the team to understand the various stresses that peripheral arterial calcifications must withstand and help them to assess how accurate their calcified vessel model is to real world conditions.

Ultrasound determination of total arterial wall thickness [19]

A scholarly journal article published in the official publication Journal of Vascular Surgery of the Society for Vascular Surgery. It is a correlation study that utilizes blood vessel imaging technology to determine the total wall thickness of various arteries among different test subject groups. The study compares the ages and peripheral artery disease states of test subjects with the total and intima-media thicknesses of their common carotid artery walls. It reveals a statistically significant correlation of the increase in peripheral artery wall thickness in patients 60-69 years old due to peripheral artery disease. The study will inform the team about the expected wall thickness of their modeled blood vessels in their calcified vessel models because of the effects of peripheral artery disease.

Cardiovascular implants — Endovascular devices (ISO 25539-2:2020) [20]

A standard written and published by the International Organization for Standardization (ISO) specifying the requirements of vascular stents and delivery systems with regards to their design, manufacturing, and evaluation among ISO member nations. It provides fundamental technical information on endoprosthesis devices such as Viabahn, including the rules and regulations they must follow. This source will inform the team on how the Viabahn endoprosthesis is to be used in their angioplasty procedures, so that its intended use can be accurately represented in the calcified vessel model.

How to design for FFF 3D printing [55]

A standard written and published by the Dutch 3D printer manufacturing company Ultimaker regarding designing for additive manufacturing (DfAM) specific to fused filament fabrication (FFF) 3D printing. It covers the most important considerations when designing for an FFF 3D printer, including the performance of printed parts, print success rates, production costs (time and materials), and the speed and efficiency of product development cycles. With this, the team can understand the benefits and limitations of FFF 3D printing, compare build material properties and suggested ideal uses, achieve even finer print details through dual extrusion, and improve their workflow through design modularity. To meet their deadline and budget goals, the team will learn from this standard to maximize their 3D printing output and success.

Product Selection Guide [56]

A standard written and published by the multinational conglomerate company 3M – Industrial Adhesives and Tapes Division regarding product selection of 3M Scotch-Weld Structural Adhesives. It provides a 3-step guide on matching a structural adhesive to a customer's design, performance, and process requirements. With this, the team can select their most difficult-to-bond substrate, determine their key design attribute, and then select the most suitable product family of 3M structural adhesives for their application. This standard also provides a brief guide on generally recommended surface preparation steps

for various substrates. With this, the team can ensure maximum adhesive strength and reliability of their adhesive bonds. To meet their deadline and budget goals, the team will learn from this standard to maximize their structural adhesive selection process and their adhesive bonding success.

3.2.3 Jamie Dellwardt

Comparing Traditional and Contemporary Manufacturing Methods [22]

This source highlights the key differences between traditional casting and contemporary 3D printing processes, particularly focusing on the limitations of each. Casting resin, while reliable for producing solid parts, often struggles with complex geometries and fine details. On the other hand, 3D printing excels in precision but can be limited by material properties and layer adhesion. This comparison will help the team weigh the benefits of both manufacturing methods, allowing the team to assess which constraints—such as cost, precision, and material strength—apply to this project. It is essential to identify which technique offers the greatest advantages while minimizing limitations in the context of the specific requirements of this project.

3D Printed Molds for Injection Molding [23]

This journal explores the effectiveness of using 3D-printed molds for liquid injection molding, especially for elastomeric devices. The study demonstrates that 3D printing can be a low-cost, rapid prototyping tool that complements traditional injection molding techniques. Combining these processes could be key for this project, as 3D-printed molds can help the team quickly iterate on designs, while injection molding may be used for final production due to its scalability and material versatility. This allows the team to strike a balance between rapid prototyping and durable, cost-effective production when considering materials for calcified lesion models.

Design For Mechanical Measurements Chapter 1 [24]

This chapter delves into the importance of replication and repetition in mechanical testing, which is directly applicable to this project. Since 12 models are being produced to undergo consistent testing, ensuring the same conditions and procedures for each is crucial. This source emphasizes the necessity of maintaining accuracy and repeatability in testing, which aligns with the project requirement to create uniform, reproducible models to validate the effectiveness of vascular intervention devices across multiple trials.

Design For Mechanical Measurements Chapter 9 [25]

Chapter 9 covers pressure measurement techniques, with a specific focus on velocity probes—tools that are vital for measuring fluid flow in vascular systems. This chapter is particularly relevant to this project, as the primary testing will involve simulating blood flow and evaluating how well each model mimics real-life hemodynamic conditions. The practical guidance offered on using and calibrating velocity probes will help inform the team's testing procedures, ensuring that the behavior of interventional devices under different flow conditions are accurately measured.

Biocompatible 3D Printing Resins for Medical Applications [26]

This article reviews various biocompatible resins used in 3D printing for medical applications, assessing their flexibility, strength, and limitations. Understanding the properties of these materials will aid in the design and prototyping phases of this project, allowing the team to select the most suitable materials for its calcified lesion models. Since the models must mimic the characteristics of arterial calcification, choosing resins that balance flexibility and durability while maintaining biocompatibility will be essential for realistic simulations.

Research Models for Studying Vascular Calcification [27]

This source provides detailed information on the biological processes that lead to vascular

calcification, offering insight into how calcified lesions form in the arteries. It also outlines the types of systems and environments that promote calcification, which will inform the team's approach to replicating these conditions in models. By understanding the key components involved in the calcification process, appropriate materials and techniques can be selected to accurately simulate arterial calcifications, making more effective models for testing vascular intervention devices.

Vascular Corrosion Casting [28]

This article discusses the use of silicone rubber in vascular corrosion casting, which is known for its ability to create detailed models of vascular systems. This method will be useful for the team, particularly in capturing the fine structures within models of calcified arteries. Additionally, the article highlights the benefits of creating multi-port models, which could be important for testing different access points for vascular devices. Incorporating these casting techniques into the prototyping phase could help ensure that the models meet their necessary structural and functional requirements.

How Cost-Effective is SLA 3D Printing [29]

This source compares the costs associated with SLA 3D printing to other manufacturing methods such as CNC machining and injection molding. It details how SLA printing offers a balance between cost-effectiveness and precision, especially for small production runs like this. Since this project involves building 12 prototypes, SLA printing may provide the most practical solution in terms of both cost and speed for initial model development. This comparison will help guide the team's choice between using 3D printing for prototyping or switching to other methods, like injection molding, for larger-scale production.

Standard Practice for Selecting Generic Biological Test Methods for Materials and Devices [30]

This document outlines the standard practices for biological testing of materials, which is relevant to this project since it is working with non-biological, medical-grade materials. While the team's models, themselves, may not need biological testing, understanding the safety and testing standards for medical devices will be important when presenting the models to stakeholders. This ensures that they are aware of potential regulatory hurdles and the necessity for further testing should the models transition into devices intended for medical use.

3D Printed Biomedical Devices and their Applications [31]

This review highlights the challenges encountered with 3D-printed biomedical devices, particularly issues like material fragility, inconsistencies in printing quality, and regulatory concerns. These are critical factors for this project to consider, as they represent potential pitfalls to avoid when designing and manufacturing the calcified lesion models. Additionally, the journal discusses advancements in 3D printing materials, offering insights into new materials that could enhance the durability and functionality of the models, especially as the technology continues to evolve.

Medical Device Software – Software Life Cycle Processes (ISO/IEC 62304) [76]

This international standard establishes a comprehensive framework for the development and maintenance of software used in medical devices, focusing on safety and regulatory compliance. It addresses the entire software life cycle, including risk management, design, implementation, verification, and maintenance. This is particularly relevant to this project if software components are integrated into the calcified lesion models for monitoring or control purposes. By following this standard, the team can ensure its models align with all relevant medical device industry requirements and maintain high safety and quality standards.

Standard Specification for Pressure Decay Leak Test Method (ASTM F2070-00(2017)) [77]

This specification defines the pressure decay leak test method for evaluating the integrity of components in medical and industrial applications. It provides detailed procedures for testing airtightness and detecting potential failures in components. This is essential for this project as it ensures that parts like

tubing and vessels used in the calcified lesion models are durable and reliable under simulated conditions. Applying this method will enhance the robustness of calcified vessel model designs and validate the integrity of model subsystems.

Water Meters for Cold Potable Water and Hot Water – Part 2: Test Methods (ISO 4064-2:2014) [78]

This standard outlines the methods for testing the performance of water meters, focusing on accuracy and durability under various conditions. Although designed for water metering, its principles are highly applicable to this project, particularly for fluid dynamics testing in the calcified lesion models. By referencing this standard, the team can ensure that its flow measurement systems meet established industry practices, thereby improving the accuracy and reliability of simulation data.

3.2.4 Scott Alex

Endovascular Simulator – Vivitro Labs [33]

Used as a benchmark, providing some direction in the assembly and design process. The source will also give the team an understanding of the flow loop systems that are used in testing and simulation of these vessel simulators. Vivitro Labs is a company that provides scalable and modular test equipment and services to cover fundamental research, early-stage, and V & V design activities. V & V is carried out in parallel with the software/system development process. These V & V activities include but are not limited to traceability analysis, evaluation, review, inspection, assessment, and testing. This source is a great bench-marker for this project.

Silicone Vessels Simulation Model Manufacturer, Vascular Simulation | Preclinic Medtech [32]

Used as a benchmark, providing an example for the overall process flow of the simulation model. This source will provide the team with some potential concepts for the vessel model overview. Silicone Vessels Simulation Model Manufacturer is a company which provides simulation vascular models for medical training, testing and operations. These trainings include virtual surgery simulators to carry out human body teaching, medical operation technology training, surgical training, surgical design and guidance, disease prediction, guide new drug development, new instrument research and development, and implementing intervention devices, etc. All silicone vessels are printed from patient-specific scans or designs (CT, MRI, 3DRA), literature values, STLs or STPs, with a highly vivid anatomical structure and operational sense, which are matched to human properties. This source is an active benchmarking source for this project scope.

CRIMSON | PLOS Computational Biology [34]

Engineering tool used for segmenting vascular structures from medical images. This source will be used as the standard in helping create accurate and detailed simulation modeling. This source utilizes an open-source software framework for cardiovascular integrated modelling and simulation. There is a lot of useful information in this source for the team to use going forward. Primarily, the team will use this source to study and research what it takes to simulate cardiovascular behavior in a vessel model. This will include the pulsatile pump system, the geometric vessel structure of any artery or vessel in the human body. CRIMSON can replicate any vessel structure in the body through their imaging software and tools.

Anatomy, Blood Vessels [35]

A textbook source used for information on the anatomy of blood vessels. The information provided detailed dimensions of the various blood vessels in the human body. This project's scope includes the femoral artery and the peripheral arterial system, in general. The team will use this source to gain additional information on dimensions of the femoral artery. The source also provides diseased state conditions of the peripheral artery and vessel anatomy.

Central Versus Peripheral Artery Stiffening and Cardiovascular Risk [36]

A scholarly journal known as the American Heart Association and American Stroke Association journals. Originally published on March 19, 2020, by the AHA/ASA journals. This source provides information on the diseased conditions of the peripheral arterial system. There's additional information concerning the mechanisms underlying arterial stiffening that has come from longitudinal studies of arterial stiffness. The team will use this source for insight on the vessel calcification and vessel wall stiffness.

Blood Flow in Vessels - Circulation [37]

A peer-reviewed source from TeachMePhysiology website that provides exceptional information on the behavior of the blood flow in vessels. TeachMePhysiology is a comprehensive, accessible encyclopedia of the physiology of the body. Created by a team of medical field scholars. The information the team is interested in is geared towards peripheral and central arterial systems. The team will use this source for the blood flow behavior in the peripheral arterial system. This source does well in relating blood flow to fluid dynamics. There is an investigation into how blood behaves based on known values such as pressure, viscosity, vessel cross section dimensions, and fluid flow.

Cardiovascular Physiology – Chapter 6: The Peripheral Vascular System; McGraw Hill [38]

A textbook source from the American publishing company McGraw Hill publishing. The textbook is Cardiovascular Physiology, 9e. The information cited and used by the team is from chapter 6 of the textbook, The Peripheral Vascular System. This chapter will aid the team in understanding the basic principles of cardiovascular transport and its role in human homeostasis. The areas of interest in this chapter for the team; Identifies the approximate percentage of the total blood volume that is contained in the various vascular segments, describes differences in the blood flow velocity in the various vascular segments and how these differences are related to their cross-sectional areas.

Tortora's Principles of Anatomy & Physiology Textbook [43]

A textbook source published by John Wiley & Sons, Inc. This source provides a comprehensive overview of human anatomy and physiology. It provides understanding of the structure and function of the human body, focusing on these two aspects. The book provides detailed illustrations, diagrams and real-world applications for comprehension on any level of competence. The team will use this source to gain insight into the relationship between structure and function of human anatomy, primarily the peripheral arterial system.

American Society of Mechanical Engineers' standard - Geometric Dimensioning and Tolerancing [70]

A manufacturing standard source from the American Society of Mechanical Engineers' standards. ASME Y14.5 - 2018 is the most recent version of the geometric dimensioning and tolerancing (GD&T). This standard provides the guidelines and specifications for defining the geometry and allowable variation of manufactured parts. Adhering to this manufacturing standard ensures the manufactured parts achieve proper fit, functionality and interchangeability. This standard will aid in the team's 3D CAD modeling standards. The team will also apply this standard to the CAD drawings for the final CAD design deliverables.

American Society of Mechanical Engineers' standard for Product Def. Additive Manufacturing [71]

A manufacturing standard from the American Society of Mechanical Engineers' that's focused on product definition for additive manufacturing. The standard is ASME Y14.46 - 2022. It provides guidelines and requirements for documenting and communicating the unique characteristics of additive manufacturing processes and products in engineering drawings and models. The team will use this as a standard in 3D printing to ensure reliability in the additive manufacturing process. The standard will also aid the team with ensuring clarity and consistency in the build orientation of the additive manufacturing

process.

3.3 Mathematical Modeling

3.3.1 Pump Power- James Anteau

One of the most important factors in creating a successful calcified vessel model is achieving a realistic flow rate and pressure within the vessel model. From the team's research on the peripheral arterial system, target values for these factors were found. The flow rate in the femoral artery, which was chosen as the subject of this model, varies between 300-400 milliliters per minute. For the purposes of this mathematical model, the higher end of this range will be used, since the model must be designed for a worst-case scenario. For system pressure, the team researched and found a worst-case blood pressure within a femoral artery of 200 mmHg []. These target values will be achieved via the pump integrated into the calcified vessel model. To be able to select an adequate pump, the power required to achieve the flow rate and pressure targets must be calculated. This is done by using the following equation for pump power. [54]

$$P_{pump} = \frac{Sg \cdot \gamma \cdot Q \cdot H}{\eta} \quad (1)$$

In this equation, Sg is the specific gravity of the fluid used to model blood, γ is the density of water, Q is the desired flow rate, H is the head developed in the system, and η is the efficiency of the pump. The values used in this equation came from additional team research about human blood properties. The values used for these variables are shown below.

$$\begin{aligned} Sg_{blood} &= 1.048 - 1.066 \\ \gamma_{water} &= 62.43 \text{ lb/ft}^3 \\ H_{max} &= 3 \text{ ft} \\ Q &= 300 - 400 \text{ mL/min} \rightarrow 0.00235 \text{ ft}^3/\text{s} \\ \eta &\approx 80\% \end{aligned}$$

After plugging these values into the equation (1), a required power of $P = 0.0011$ horsepower is found. This value is similar to the power produced by a human heart, which suggests that the team is on the correct path with their calculations. However, this value reflects an ideal scenario in which there is no friction within the arterial system. Once a more accurate calculation for head in the system is performed, a more accurate pressure value will be calculated.

3.3.2 Calcified Lesions - Gavin Lazurek

A statistical analysis was performed on the results of a medical study to characterize disease states of peripheral arterial disease (PAD). The disease presents differently in different patients, so a disease state which is applicable to the intended function of the calcified vessel model was necessary to ascertain. The EuroIntervention study, *A new optical coherence tomography-based calcium scoring system to predict stent under expansion*, proposes that predictive factors of stent under expansion in angioplasty procedures on peripheral arterial plaque include plaque length greater than 5 mm, plaque thickness greater than 0.5 mm, and degree of vessel occlusion greater than 50% [12]. To determine the statistical significance of these claims, a two-tailed A/B test was performed on data collected by the study.

The purpose of a two-tailed A/B test is to determine whether a change to an experiment produced a statistically significant effect, either an increase or a decrease, in its success rate. The test requires the calculation of a z-score and p-value, using the following formulas [14].

$$z = \frac{\bar{x} - \mu}{\frac{\sigma}{\sqrt{n}}} \quad (2)$$

$$p = P(z < -z_{crit}) + P(z > z_{crit}) \text{ or } P(z < -z_{crit}) \quad (3)$$

In formula (2), a z-score is calculated according to the sample mean, \bar{x} , the population mean, μ , the standard deviation, σ , and the sample size, n . In formula (3), the p-value is calculated according to the probability that a z-score is outside the range of a critical z-score, z_{crit} . For example, among patients with less than 50% vessel occlusion, 3 of 33 experienced an incomplete stent expansion, resulting in a sample mean of 0.0909, a standard deviation of 0.2919, and a sample size of 33. Among patients with more than 50% vessel occlusion, 7 of 24 experienced an incomplete stent expansion, resulting in a sample mean of 0.2917, a standard deviation of 0.4643, and a sample size of 24 [12]. The critical z-scores of 1.645 and 1.282, respectively, were found in Appendix C of *Probability and Statistics* according to the parameters of this A/B test [14]. These values were then inputted into an A/B test calculator provided by ABTestGuide.com for analysis, the results of which are shown in Figure 5.

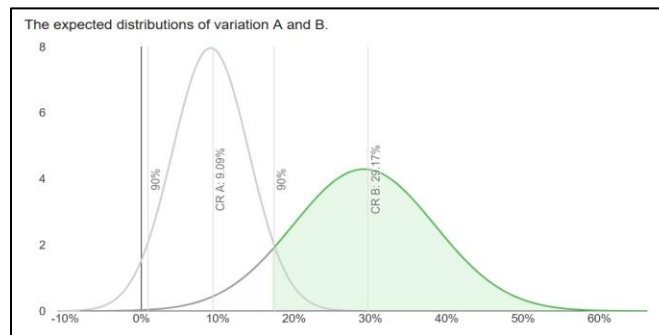

Figure 5 - Two-tailed A/B test for degree of vessel occlusion vs stent under expansion rate

The results of this A/B test show a z-score of 1.9044 and a p-value of 0.0569. This translates to greater than 90% significance regarding the change in experimental success rate. The 90% confidence interval was deemed to be acceptable for the small sample size of the angioplasty procedure data. The factors of plaque length and plaque thickness were both calculated using the same A/B test method and both changes in experimental success rate were found to have greater than 99% significance. Based on these calculations, the calcified vessel model will establish baseline dimensions of modeled calcified plaque as 5 mm in length, 0.5 mm in thickness, and 50% degree of vessel occlusion, as these factors have been determined to be the critical values at predicting stent under expansions in angioplasty procedures. For accurately representing the wide range of disease states of PAD, three calcified plaques will be modeled at dimensions less than, equal to, and greater than these critical values. The usefulness of the calcified vessel model would be greatest if it can accurately represent a best-case scenario, an average scenario, and a worst-case scenario for testing of medical devices across their entire expected range of PAD states.

3.3.3 Cost Analysis - Jamie Dellwardt

This section of the report presents a cost analysis on the production of calcified vessels using two primary methods: 3D printing and injection molding. The analysis is based on specific assumptions and calculations, providing insights into the relative costs of each method. The analysis considers a production of 12 replicable calcified vessels. The following variables and assumptions were used in the calculations:

Product: Calcified vessels

Production Methods: 3D printing and molding

Quantity: 12 units

Variable Costs: Resin, tubing, syringes, labor, shipping for both methods

Estimated cost savings of \$22 per unit for molding compared to 3D printing.

Fixed Costs: Pump, tank, cart, blood solution, and other miscellaneous fixed costs

In order to calculate a total cost of each method for all variable costs, the following equations for variable costs were used:

$$C_v = C_m + L + Oh \quad (4)$$

$$pC_v = Resin + Tubing + Syringes + L + Oh \quad (5)$$

The inputs and results of the equations are presented in Table 1, below. These values reflect the estimated costs for producing a single vessel model.

Table 1 - Variable Cost

Method	Resin	Tubing	Syringes	Labor	Shipping	Total
3D Printing	\$3.44	\$8.91	\$65	\$22.49	\$70	\$169.84
Molding	\$18.00	\$8.91	\$65	\$0.00	\$70	\$147.84 (estimated)

After calculating the individual variable cost, the total variable cost (TC_v) for all 12 models was calculated. The totals are presented below.

Table 2 - Total variable cost

Method	TC_v
3D Printing	\$2,038.08
Molding	\$1,774.08

The total variable cost is calculated by taking the individual variable cost multiplied by the number of units. The fixed cost is the sum of all the one-time purchases and the costs no matter the manufacturing processes chosen. The fixed cost for this project is currently estimated to be \$323.97. The next significant calculation is for the total cost of the entire 12 models.

$$TC = C_f + TC_v \quad (6)$$

Table 3 - Total Cost for each process

Method	TC
3D Printing	\$2,362.05
Molding	\$2,098.05

In order to maintain purchasing costs under the project budget, the cost per unit was calculated to ensure there would be enough room to purchase all needed materials for the remaining models. This was done by dividing total cost by the number of units.

Table 4 - Cost per unit for each process

Method	A
3D Printing	\$196.84
Molding	\$174.84

Based on the calculation results, molding is a more cost-effective method for producing calcified vessels compared to 3D printing. The average cost per unit is lower for molding due to reduced variable costs associated with materials and labor. However, it is important to note that this analysis is based on specific assumptions and calculations. Other factors such as quality, lead time, and production scale should also be considered when making a final decision. Further analysis and evaluation may be necessary to determine the optimal production method for specific requirements and circumstances.

Based on the cost analysis results, it is recommended that the team consider adopting injection molding as the primary production method for calcified vessels. However, further research and analysis should be conducted to evaluate the overall suitability of each method for project-specific requirements such as quality standards and production capacity. Additionally, exploring potential cost-saving strategies within the molding process, such as material optimization or process improvements, could further enhance the economic viability of this method.

3.3.4 Filament Usage – Jamie Dellwardt

In this section, the engineering calculations necessary to determine the filament length required for constructing a calcified vessel model using 3D printing are presented. The calculations begin by determining the solid volume of the vessel, based on its outer diameter and length. Using the formula for the volume of a cylinder:

$$\text{Solid Volume} = \frac{d^2\pi l}{4}$$

where $d = 8 \text{ mm}$ and $l = 12.4 \text{ mm}$, the solid volume was calculated as:

$$\text{Solid Volume} = \frac{8^2\pi * 12.4}{4} = 623.29 \text{ mm}^3$$

Next, the interior (hollow) volume of the vessel, representing the inner portion, was calculated using the same formula but with the inner diameter $d = 6.2 \text{ mm}$:

$$\text{Interior Volume} = \frac{6.2^2\pi * 12.4}{4} = 350.60 \text{ mm}^3$$

To determine the volume of the material needed to construct the vessel, the interior volume was subtracted from the solid volume, yielding:

$$\text{Volume of Hollow Model} = 623.29 \text{ mm}^3 - 350.60 \text{ mm}^3 = 272.69 \text{ mm}^3$$

Finally, to calculate the required filament length, the volume of the hollow model was related to the filament's cross-sectional area using the formula:

$$\text{Volume} = \text{Filament Length} * \left(\frac{\text{Filament Diameter}}{2} \right)^2 \pi$$

Given the filament diameter $\text{Filament Diameter} = 1.75 \text{ mm}$, solving for the filament length results in:

$$272.69 \text{ mm}^3 = \text{Filament Length} * \left(\frac{1.75}{2} \right)^2 \pi$$
$$\text{Filament Length} = 113.37 \text{ mm (or } 0.11337 \text{ m)}$$

In conclusion, the filament length required to fabricate the calcified vessel model is approximately 113.37 millimeters. This calculation ensures that the appropriate amount of material is available for 3D printing the model and is crucial for proper planning and execution of the fabrication process.

3.3.5 Wall Shear Stress – Scott Alex

Wall shear stress in this context is defined as the frictional force exerted by flowing blood on a vessel wall. It represents the tangential force exerted by the blood flow on the endothelial lining of the vessel walls. The wall shear stress calculation is an important biomechanical parameter in blood vessels. This stress significantly influences the evolution of atherosclerosis in the arterial and vessel system. Wall shear stress calculation in blood vessels helps indicate atherosclerosis development and progression to calcification in the blood vessel [34]. Though calcification is not the same as atherosclerosis, it commonly occurs and develops in parallel together [33]. Calcification in the arterial system is a buildup of calcium deposits that, over time, leads to development of calcified plaque adhered to the wall of the vessels. Atherosclerosis is fatty deposit buildup in the arterial system also known as plaque in the arterial system. Wall shear stress, calcification, and atherosclerosis are all related factors.

Applying fluid mechanic principles to blood flow in a blood vessel this wall shear stress calculation can be used to determine the appropriate wall thickness of the model. Below will be the team's model calculation for wall shear stress. Blood flow is the important parameter in this calculation, so the team will do extensive research into blood modeling for the process. The team aims to construct a blood substitute that is almost a match to the dynamic viscosity of human blood. This will ensure the vessel model to be accurate to the human body function. This calculation will use dimensions that are common to the femoral artery, as the team will be focusing on this particular artery for the calcified vessel model.

Calculation considerations:

1. Assume laminar flow
2. Viscosity (μ) of blood/blood substitute is complex
3. Shear rate also needs to be calculated [36]
4. Flow velocity (V_{\max}) is used for arteries with peripheral arterial disease (PAD)
5. Radius value (R) [37]

Known values:

$$\begin{aligned}
 V_{max} &= 0.3 \text{ m/s} \\
 R &= 0.005 \text{ m} \\
 \mu &= 0.0035 \text{ Pa} \cdot \text{s}
 \end{aligned}$$

Calculate shear rate:

$$\begin{aligned}
 \frac{du}{dy} &= \frac{2V_{max}}{R} & (7) \\
 \frac{du}{dy} &= \frac{2(0.3 \text{ m/s})}{0.005 \text{ m}} \\
 \frac{du}{dy} &= 120 \text{ s}^{-1}
 \end{aligned}$$

Calculate wall shear stress (WSS):

$$\begin{aligned}
 \tau &= \mu \cdot \frac{du}{dy} & (8) \\
 \tau &= (0.0035 \text{ Pa} \cdot \text{s}) \cdot (120 \text{ s}^{-1}) \\
 \tau &= 0.42 \text{ Pa}
 \end{aligned}$$

The results of this calculation show that the wall shear stress calculation for the blood vessel dimensions (femoral artery dimensions) is equal to the value of 0.42 pascals. This is a small value; it represents the shear force exerted by the blood substitute on the model vessel wall under the given conditions. The team will need to consider this value when selecting filament material for the 3D print of the model to withstand the pressure and flow of the blood substitute. The model blood vessel wall thickness will match the femoral artery thickness at 1 to 2 mm, so the material will need to withstand this stress value. If the team does not consider this stress value, there could be potential aneurysm formation or vessel wall failure, which are not desired simulated use conditions for this model.

4 Design Concepts

This section of the report contains four subsections which aim to offer insight into the design process of the project across several key stages of transforming the project requirements into a viable, cohesive solution. Section 4.1 breaks down the overall system into their essential physical components and their associated functions. Section 4.2 explores design concepts with various approaches for fulfilling the design requirements provided in the QFD, resulting in many potential subsystem solutions. And Section 4.3 shows how these design concepts are evaluated against selection criteria derived from the project's customer and engineering requirements, quantifiable through calculations and/or part specifications. Section 4.4 discusses and shows the selection process through a variety of tools. A CAD of the current state of the overall design and pipe flow diagram are provided at the end of this section.

4.1 Functional Decomposition

The team created a physical decomposition of the calcified vessel model to aid in the concept generation stage of the design process. The overall calcified vessel model can be broken down into several subsystems and components. Each subsystem and component will serve a role in replicating the desired physiological conditions in human patients. This decomposition covers both the physical process, and the functional aspects required for the calcified vessel model and its purpose of facilitating medical testing and research studies for the deployment of arterial intervention devices.

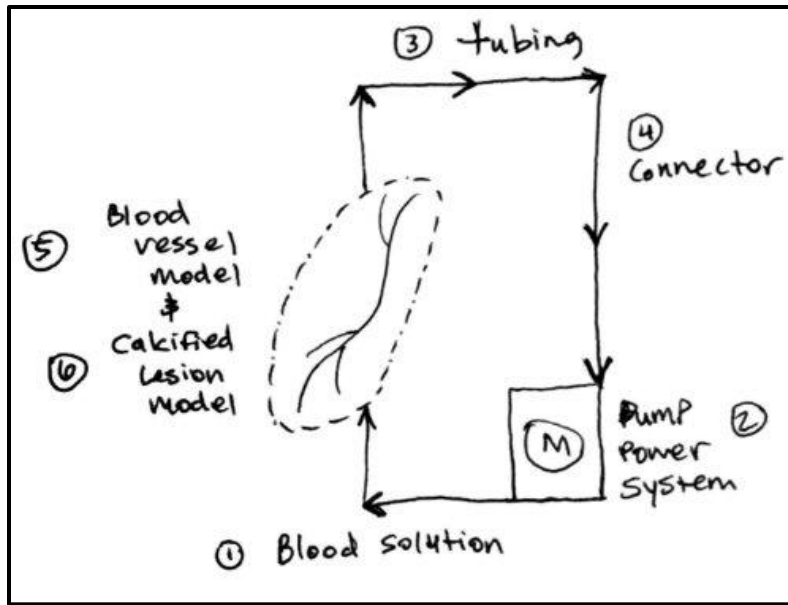

Figure 6 - Process flow of calcified vessel model

System:

Calcified Vessel Simulation Model

Components:

- | | | |
|---|--------------------------------------|---|
| 1. Blood Substitute
<i>simulates blood</i> | 3. Tubing
<i>directs flow</i> | 5. Blood Vessel Model
<i>simulates femoral artery</i> |
| 2. Power/Pump
<i>produces flow</i> | 4. Connectors
<i>joins system</i> | 6. Calcified Lesion Model
<i>simulates calcification</i> |

The team created a hierarchy chart for a better visual of the components and the subsystems involved in this calcified vessel model design. The intention behind this chart is to aid in design considerations for the entire project. The chart will list the physical components and the subsystems within each component. Paired with the above decomposition, this chart will delve deeper into the design and connect the required parts needed for this calcified vessel model to successfully simulate human physiological conditions. The hierarchy chart is as follows.

Physical Components:

Blood Vessel Structure

- >femoral artery model
- >branching vessels (optional)
- >calcification model
 - >>lesion material
 - >>lesion adhesion
 - >>lesion variations

Materials

- >vessel material
- >calcified lesion material
- >blood substitute material

Fluid Flow Process

- >pump system
 - >>pulsatile frequency
 - >>steady frequency
- >plumbing tubing

Metrology

- >data acquisition software/computer
 - >>pressure sensors
 - >>flow meters
 - >>feedback loop

Model Support Structure

- >transportable cart
- >resting mounts

4.2 Concept Generation

4.2.1 Top-Level Design

For the overall design of the model, three concepts were generated with varying locations of each sub-function component within the calcified vessel model. The top-level design is crucial to the success of the project, as it is what the team will use to plan the mounting of parts needed to achieve the project goals. It consists of a medical cart with a top and a bottom shelf, upon which an artery model, an Arduino module, a blood analog reservoir, and a pump are mounted in various locations.

The first design concept places the computing and pump module on the top shelf of the medical cart, while the artery model, and the blood analog tank are on the below shelf.

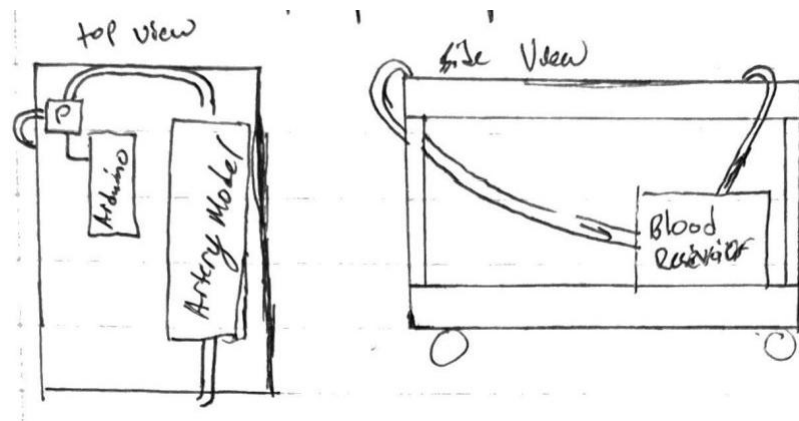

Figure 7 – Top-level design concept 1

This concept has the benefit of easy access to the electronics and the pump for any necessary maintenance and/or upgrades. However, this position for the electronics places them in the way of potential fluid spillage if a structural failure were to occur within the artery model. If this occurred, the electronic units would be permanently broken, and the team would need to replace them. Though the electronics are in danger, the pump will be in an advantageous position that reduces the head which the pump must overcome to create flow within the model. This is advantageous because it allows for the team

to use a more cost-effective pump, since its necessary power will be lower than in other locations.

The second design concept features a top-level design in which the pump and electronics are placed on the lower shelf of the cart with the blood analog tank, leaving the artery model as the only component on the upper shelf of the cart.

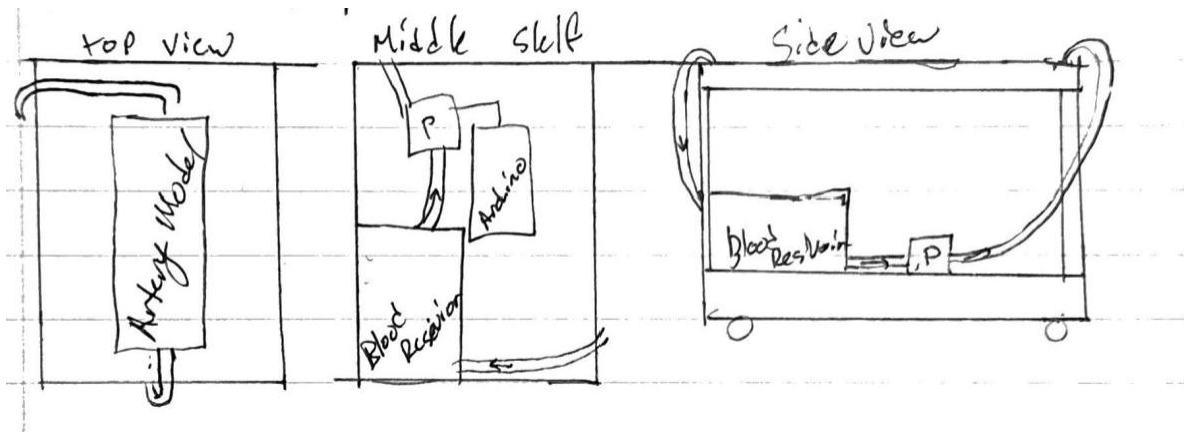

Figure 8 – Top-level design concept 2

This design has the advantage of featuring only the artery model on the top cart shelf, leading to a better user experience as defined in the customer need for ergonomics. However, there are several disadvantages to this design. The first of these disadvantages is the fact that the pump and electronics are in danger of fluid spillage, since they will be placed next to the blood analog reservoir. If any aspect of the tank were to fail, the electronics will be permanently broken. On top of this, the head for the pump to overcome is the greatest of the three concepts.

The final design concept for the top-level design is a mixture of the first two. This concept has the pump and electronics be undermounted on the top shelf of the cart. The artery model is placed by itself on the top of the cart, and the blood analog tank is placed on the bottom shelf, like the other two concepts.

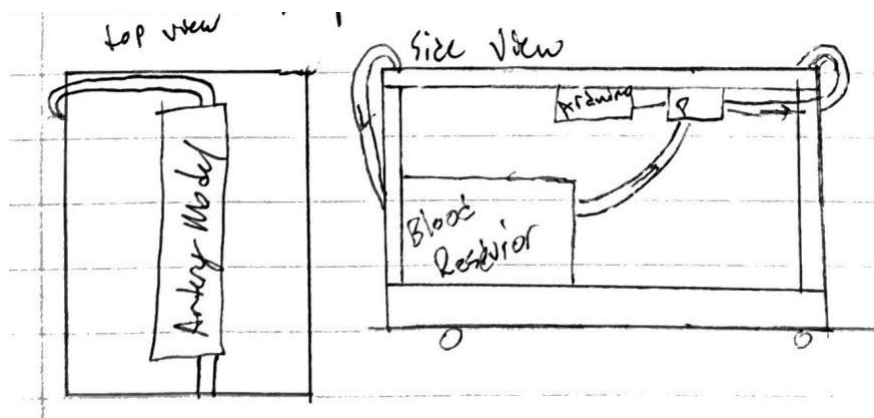

Figure 9 – Top-level design concept 3

With the position of the pump being undermounted on the top of the cart, this concept has the advantage of featuring only the artery model being atop the cart, while also minimizing the head for the pump to overcome. Additionally, the pump and electronics are in a position such that the risk of fluid spillages damaging them is minimized, since they are not resting on the same surface as any of the other components which circulate the blood analog.

4.2.2 Calcified Lesion Material

Three design concepts were generated for the subfunction regarding the material of the modeled calcified lesion. The lesion material is crucial to the success of the calcified vessel model because some material properties of the lesion were specified in the project outline and reflected in the customer requirements and engineering requirements.

The first concept is a high-hardness 3D printer filament, shown below, which would use additive manufacturing via a 3D printer to form it to the correct geometric specifications of a calcified lesion.



Figure 10 – High-hardness 3D printer filament

The 3D printer filament concept has the benefit of maintaining a consistent hardness across production runs, as its vendors guarantee consistency in the material properties of their products. Furthermore, the hardness of the filament can be accurately chosen due to the wide selection and precise hardness specifications of 3D printer filaments available on the market. The 3D printer filament concept also has the benefit of a high resolution, as 3D printers maintain sub-millimeter precision. It would also guarantee the capstone team complete control of their manufacturing process, resulting in faster lead times and the ability to make rapid design changes. However, the 3D printer filament concept was found to be relatively expensive compared to other design concepts within this subfunction [1].

The next concept is a fired ceramic, shown below, which would be modeled out of mid-high fire clay to the shape of a calcified lesion and fired in a kiln until the part is hard, dry, and nonporous.



Figure 11 – Fired ceramic

The fired ceramic concept is beneficial for its material properties similar to real calcified plaque (which is primarily made of ceramic materials) that go beyond the specific material properties requested by the client. The fired ceramic concept also benefits from a relatively easy manufacturing process, relying on ancient technology such as molds and kilns. Fired ceramic is also the least expensive of the design concepts within this subfunction. However, the fired ceramic concept lends itself to inconsistent hardnesses across production runs, as the heat and application of the kiln cannot be precisely controlled. In addition, this concept cannot offer high resolutions, as mid-high fire clay is a malleable material and is susceptible to warping during the firing process [2].

The final concept is a high-hardness steel, shown below, which would use subtractive manufacturing via a CNC machine to form it to the correct geometric specifications of a calcified lesion.



Figure 12 – High-hardness steel

The high-hardness steel concept has the benefit of consistent hardness across production runs, as the composition and manufacturing of steel is kept consistent by its producers, and its hardness remains the same after machining. The steel concept also benefits from a very high resolution, as CNC machining can achieve sub-millimeter precision. However, the steel concept suffers from a complex manufacturing process due to the nature of CNC machining. This may result in longer lead times and the inability to make rapid design changes. Furthermore, the hardness of steel is limited by the capabilities of CNC machines, so the desired hardness of a calcified lesion may only be offered by steels which are too hard for CNC machines to cut [3].

Product images were provided by www.amazon.com.

4.2.3 Calcified Lesion Adhesion Method

Three design concepts were generated for the subfunction regarding the adhesion method of the modeled calcified lesion to the modeled blood vessel. The adhesion method is crucial to the success of the calcified vessel model, as some adhesive properties of the lesion were specified in the project outline and reflected in the customer requirements and engineering requirements.

The first such concept is an adhesive paste or tape, shown below, which would be applied between the modeled lesion and vessel and allowed to set until its maximum adhesive strength is reached.

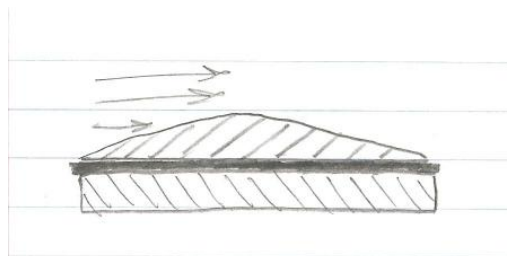

Figure 13 – Adhesive paste or tape

With the adhesive paste or tape concept, the adhesive strength can be accurately chosen due to the wide selection and precise adhesive strength ratings of adhesive pastes and tapes available on the market. The concept also has the benefit of requiring no additional manufacturing complexity. The paste or tape should be ready for application as purchased, and the lesion and vessel require no additional geometric features. However, the adhesive paste or tape concept suffers from requiring additional assembly complexity, as the process of applying the paste or tape to the vessel and lesion can be complicated and/or difficult. It may also require a substantial amount of time for the adhesive to set until its maximum adhesive strength is reached, resulting in delays before prototyping and testing.

The next concept is an interlocking mechanism between the calcified lesion and blood vessel, shown below, which would resist separation forces between the two parts and be comprised of a protruding feature on one part and an intruding feature on the other.

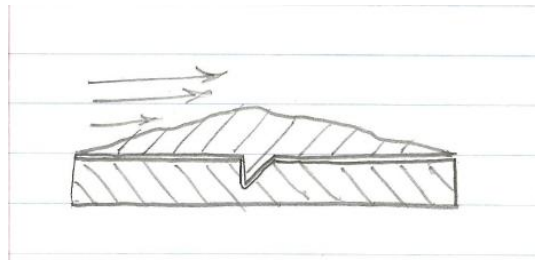

Figure 14 – Interlocking mechanism

With the interlocking mechanism concept, the adhesive strength can be accurately controlled through careful manipulation of the part geometries to generate the desired forces between them. The concept also has the benefit of requiring little additional assembly complexity. The two parts should be able to snap into place and hold themselves together once assembled. However, the interlocking mechanism concept suffers from requiring additional manufacturing complexity, as small protruding and intruding geometries on the two parts may be difficult for the chosen manufacturing method to generate. In addition, the adhesion strength which the concept can model is limited in application. An interlocking mechanism may only be able to model shear adhesion strength and not normal stress, and the model could not be rotated if it relies on gravity to model adhesion strength.

The final concept is an embedded calcified lesion within the wall of the blood vessel, shown below, which would model adhesion strength by being completely enclosed within the surrounding wall, as is found in certain disease states of PAD.

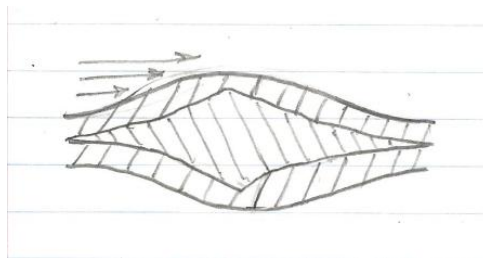

Figure 15 – Embedded lesion

The embedded lesion concept benefits from requiring little additional manufacturing complexity. There are no protruding or intruding geometries present on either part, so both can be manufactured according to their original specifications. In addition, the concept does not require the application of adhesives. However, the embedded lesion concept suffers from the inability to accurately control the adhesive strength of the lesion, as that is entirely determined by the yield strength of the modeled blood vessel wall enclosing it. Furthermore, the concept introduces additional assembly complexity because enclosing the lesion within the vessel wall may present a difficult engineering challenge. The concept is also inaccurate to the scope of the calcified vessel model, as embedded lesions are most common in lower-leg arteries, while the model will represent the femoral artery located in the upper-leg [13].

4.2.4 Blood Analog

In developing a calcified vessel model, selecting a suitable blood analog to accurately model human blood is critical to the overall success of the project. Various options for this sub-function were considered, with each offering distinct advantages and disadvantages, as well as the potential for visual documentation of each solution or mixture. These options are listed as follows.



Figure 16 – Glycerin

Glycerin stands out as a top option due to its high transparency and non-biological nature, allowing researchers to directly observe internal processes such as blood flow and interactions with calcified lesions in real time. This feature is particularly beneficial for assessing the efficacy of vascular intervention devices, as it enables the visualization of flow patterns and potential areas of turbulence. However, its higher cost compared to other alternatives—often due to its purity and expensive manufacturing processes—can be a limiting factor for budget-conscious projects. Additionally, while glycerin is generally safe to use, it requires specific safety protocols during handling, such as the use of personal protective equipment (PPE) to mitigate risks of skin and eye irritation.



Figure 17 - Simulated blood

Simulated blood closely mimics the viscosity and flow characteristics of real blood, making it suitable for various experimental conditions where fluid dynamics are crucial. Its formulation incorporates components that replicate the cellular makeup of blood, enhancing its realism in flow studies. However, its opaqueness restricts visibility, complicating direct observation and making it difficult to visualize interactions of vascular devices with the model. Furthermore, the absence of standardized safety guidelines for simulated blood further complicates its use, as researchers must conduct their own risk assessments, which may introduce variability into experimental setups.



Figure 18 - Corn syrup, water, and flour mixture

A mixture of corn syrup, water, and flour presents a highly customizable and cost-effective solution, allowing researchers to adjust the proportions of components to create tailored viscosity and flow properties that can simulate different physiological conditions. This adaptability can be particularly useful in mimicking pathological states, such as for an increased blood viscosity associated with certain diseases. However, this method requires significant preparation and mixing time, which can add logistical challenges and delay experiments. Additionally, the mixture may harden over time, leading to potential inconsistencies in viscosity and flow characteristics that could compromise the reliability of test results.



Figure 19 - Doppler ultrasound gel

Doppler ultrasound gel is easily accessible and relatively inexpensive, which is generally advantageous for initial testing or for budget-restrictive projects. Its formulation provides a smooth texture that can reduce friction in flow models, which is beneficial for certain applications. However, its higher viscosity compared to blood can impede fluid movement and limit its effectiveness in accurately replicating blood flow dynamics within the model. Furthermore, the gel's opaqueness hinders internal observations, which is essential for understanding flow patterns and device interactions with the model.



Red Blood Cells

Figure 20 - Red blood cell surrogate

Red blood cell surrogates provide a highly realistic representation of blood's rheological properties, closely mimicking the behavior of real red blood cells in a flow environment. This realism can significantly enhance the predictive accuracy of the model regarding how vascular devices interact with human blood. However, these surrogates may not accurately reflect the properties of blood in individuals with specific health conditions, such as anemia or sickle cell disease, limiting their applicability across a wide range of scenarios. Furthermore, ethical considerations surrounding the use of biological materials can complicate sourcing and increase the number of regulatory hurdles.



Figure 21 - PEG 200 polyethylene

Lastly, the PEG 200 polyethylene mixture closely resembles blood properties, offering the potential for excellent simulation of blood behavior, particularly in terms of shear-thinning properties and viscosity. However, it tends to be more expensive than other alternatives, which may pose budgetary constraints, especially in larger-scale studies. Its limited availability can also be a challenge, as not all laboratories have ready access to this material. Additionally, the use of PEG requires adherence to complex safety protocols, including potential toxicity evaluations, which can introduce further logistical challenges for researchers.

Ultimately, the optimal blood solution will depend on carefully weighing these factors—desired realism, cost, availability, and ethical considerations—necessitating further research and experimentation to determine the most suitable option for the model. This comprehensive analysis underscores the importance of aligning the choice of blood solution with the specific goals and requirements of the calcified vessel model project.

4.2.5 Blood Vessel Design

Several design concepts were generated for the overall design of the blood vessel used in the calcified vessel model. The chosen design of the blood vessel is crucial to satisfying the client's needs for

this project. There were three leading concepts that adhered the best to the relevant customer needs and engineering requirements. With these diverse concept generations, the team can better understand which designs meet their goals and filter out designs that don't meet the customer requirements and engineering requirements. The following will review each concept generation and evaluate how each one may or may not address the key goals of the calcified vessel model.

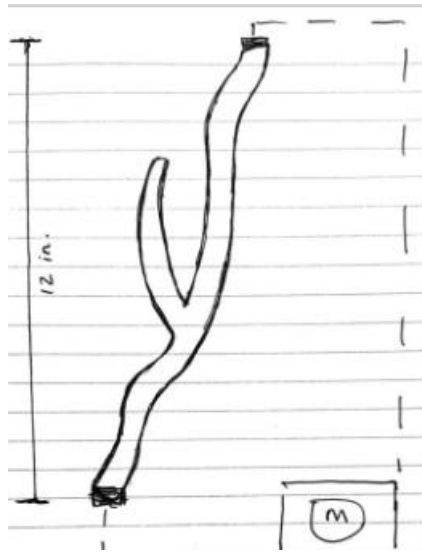

Figure 22 - Femoral artery (R)

The first generated design concept for the blood vessel design is the right side of the femoral artery. This design only features the femoral artery on the right side of the human body. The femoral artery is a common vessel site for calcifications in the peripheral arterial system. With this design, there will be less fluid volume to manage, and thus less power requirement to move the fluid through the system, compared to other concepts. The dimensions for the femoral artery will be more manageable as well. Furthermore, the cost to manufacture twelve units of this design is expected to fall within the allocated project budget. It will relatively be 12 to 18 inches in length, and less than 0.4 inches in vessel diameter. It will have two or three vessel branches off the main vessel to match the real femoral artery. The relatively small size of this vessel design concept will aid in the pump system, as the relative lack of complex geometry in the vessel design boosts the efficiency of the process flow.

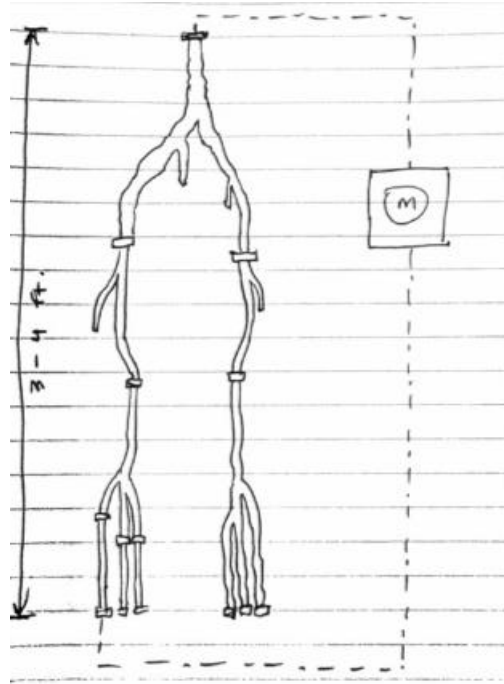

Figure 23 - Lower extremities

The second generated design concept for the blood vessel design is the lower extremities design. This design features the main arterial system of the lower extremities. The system spans from the hips to the feet. The lower extremities of the peripheral arterial system are common vessel ranges for calcifications. Unfortunately, the cost to manufacture twelve units of this design is expected to fall outside the allocated project budget. This design will require a greater fluid volume to manage, which could lead to complications in the process flow. More fluid volume requires more power to move the fluid through the system. This design is relatively large with a length of 3 feet, and complex with various vessel diameters throughout the model. The model will be broken up into sections of vessels with fittings and connectors used to assemble the model; the model will not be manufactured as one part. The large size of this model requires more power from the pump system. The complex geometry of the vessel design could also create issues within the pump flow.

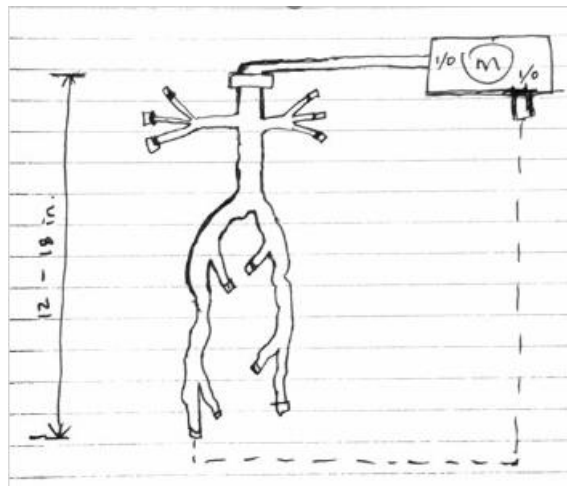

Figure 24 - Femoral artery (R & L)

The third generated design concept for the blood vessel design is the right and left sides of the femoral artery. This design features both the femoral arteries on the right and left sides of the human body. As mentioned before, the femoral artery is a common vessel site for calcifications in the peripheral arterial system. The fluid volume for this design would fall in the middle of the two previous concepts but would still be considered manageable in terms of the required power to move the fluid through the system. The cost to manufacture twelve units of this design is expected to fall within the allocated project budget. The size of the model will be 12 to 18 inches in length and less than 0.4 inches in vessel diameter. The design will match the real femoral arteries. The relatively small size of this vessel design concept will aid in the pump system, as it does not require a large fluid volume, and the geometry of the vessel design is not complex compared to other concepts.

4.3 Selection Criteria

4.3.1 Top-Level Design

The selection criteria for the top-level design includes the customer requirement of ergonomic for intended use, as well as the engineering requirement of power required for the pump to overcome the head of the system, from the project QFD. From the calculations in Section 3.3.1 of this report, it is known that the closer in elevation the pump is to the artery model within the design, the lower the head of the system will be. Additionally, to achieve the ergonomics the client wishes for, only the artery model should sit on the upper shelf of the medical cart. The final design will likely be different from the one chosen for prototyping, because testing the project subsystems will lead to further development of an optimized design. The difference in cost for the three concepts in this section will be negligible since the components are the same, with only their layout differing.

4.3.2 Calcified Lesion Material

The selection criteria used for concept selection of calcified lesion materials include three engineering requirements from the QFD: lesion properties, lesion dimensions, and cost. Within lesion properties, a material hardness of Shore 39D is desired to accurately model the hardness of calcified lesions. Within lesion dimensions, a resolution of as small as possible is desired to accurately manufacture the subtle geometric features of calcified lesions. And for cost, a purchasing and manufacturing cost as close to \$0 as possible is desired to keep the project under its allotted budget.

To calculate the hardness of the calcified lesion and compare it to those of the design concepts, their material hardnesses need to be identified and converted to a common unit of measurement. The project outline requested that calcified lesion hardness be expressed in durometer, which follows the Shore D scale, so all hardness values identified would be converted to their Shore D equivalent. Calcified lesion hardness was identified to be ~274 on the Vickers hardness scale, based on experimental testing of similar hydroxyapatite/calcium phosphate deposits within the human body [9]. The hardness of the 3D printer filament, the fired ceramic, and the 304 steel were identified to be 90 on the Shore A scale, 4 on the Mohs hardness scale, and 215 on the Brinell hardness scale, respectively, based on available specification sheets for each material [1][2][3].

Using hardness conversion tables and calculators provided by www.plantech.com, www.efunda.com, and www.carbidedepot.com, the identified hardness values of the three materials were converted to their Shore D equivalents. The target hardness of the calcified lesion was calculated as Shore 39D, while the hardnesses of the 3D printer filament, fired ceramic, and 304 steel were calculated as Shore 39D, Shore 44D, and Shore 33D, respectively. These conversions allow for direct comparison of

hardnesses between the target value and the design concepts, and design concepts will be evaluated on the proximity of their hardness value to that of the target hardness value.

4.3.3 Calcified Lesion Adhesion Method

The selection criteria used for concept selection of calcified lesion adhesion method include three engineering requirements from the QFD: lesion properties, lesion dimensions, and cost. Within lesion properties, an adhesive strength of at least 27 pascals is desired to accurately model the minimum adhesive strength of calcified lesions. Within lesion dimensions, dimensions of protruding or intruding geometries as close to zero as possible are desired to most accurately model real-world calcified lesions. And for cost, a purchasing and manufacturing cost as close to \$0 as possible is desired to keep the project under its allotted budget.

To calculate the minimum adhesive strength of calcified lesions, a fluid mechanics force analysis was performed on the system including the blood vessel, blood flowing through the vessel, and calcified lesion inside the vessel. The minimum shear adhesive strength required due to blood flow, P_{min} , is equal to the force of the blood flow on the cross-sectional area of the lesion, F , divided by the contact area between the lesion and vessel, A . This is represented by equation (9).

$$P_{min} = F/A \quad (9)$$

The force of the blood flow on the cross-sectional area of the lesion, F , is the product of the lesion's degree of vessel occlusion, the blood volumetric flow rate (Q), the blood density (ρ), and the blood velocity (v), represented by equation (10) [4]. The blood volumetric flow rate was assumed to be its maximum recorded value within the femoral artery. The contact area between the lesion and vessel is the product of the lesion's degree of vessel occlusion, π , the artery's inner diameter (d), and the lesion length (L), represented by equation (11). The lesion was assumed to be a perfect half-cylinder with a diameter equal to that of the femoral artery inner diameter, as shown in Figure 25. The degree of vessel occlusion variable ultimately cancels out in equation (9), so it is omitted from both equations (10) and (11).

$$F = Q\rho v \quad (10)$$

$$A = \pi dL \quad (11)$$

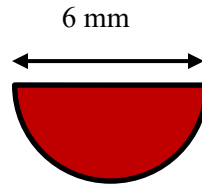

Figure 25 – Calcified plaque in femoral artery cross-section

Through the results of medical experimental studies, the maximum volumetric flow rate of blood in the femoral artery was determined to be $8.183 \times 10^{-6} \text{ m}^3/\text{s}$ [5], and the inner diameter of the femoral artery was determined to be 6 mm [7]. With these values, the velocity of blood in the femoral artery can be derived as 0.2894 m/s. The lesion length was taken to be 5 mm, which was established as the baseline length of calcified plaque for PAD in Section 3.3.2. The average density of human blood was taken to be 1060 kg/m^3 [6].

When these values are inputted into the above equations, the minimum shear adhesive strength required due to blood flow is found to be 26.63 pascals, which rounds up to 27 pascals. Based on this result, all calcified lesion adhesion method design concepts will be evaluated on their ability to meet and exceed this value for minimum shear adhesive strength between the modeled blood vessel and calcified plaque under simulated use conditions.

4.3.4 Blood Analog

When selecting a proper blood analog for calcified vessel modeling, several critical selection criteria must be considered to optimize model performance. The foremost criterion is density, as it is the primary factor that influences fluid dynamics within the model. The density selection must be in line with physiological conditions so that fluid in the model behaves like blood. This would be beneficial in the assessment of device performance in vivo; for accurate results, the model must obtain the exact density which significantly relates to device efficacy.

Cost is another vital consideration, especially for research projects with scant provisions in terms of funding. The appropriate concept shall allow performance and cheapness to go hand in hand, thereby enabling the extensive testing and experimentation that the project normally requires without the detrimental concern of achieving high costs. This is crucial information in ensuring that different choices remain in line with resource allocation.

Viscosity is critical for the correct simulation of blood flow behavior. Viscosity is the one test where a chosen model should be modeled to closely and accurately represent blood in terms of various shear and pseudo shear rates. This is necessary, especially in assessing the interaction of intervention devices with the fluid, as the flow patterns and, in turn, the device performance may vary significantly with the change in viscosity. The final target viscosity stands at around 10 cp. Solubility plays a significant role in the compatibility of the blood solution with other materials used in the model. A solution with appropriate solubility characteristics can facilitate interactions between different components, enhancing the model's fidelity. This compatibility is crucial for accurately representing biological conditions and ensuring that the model behaves as expected.

Manufacturing considerations also come into play in blood solution selection. How easy it is to manufacture, and the availability of the chosen solution could tremendously impact the modeling process. Solutions such as these that insert little to no sacrifice regarding the setup time and effort will allow researchers to spend more of their energy on experimentation and analysis, thus streamlining the entire operation.

Being transparent is an important parameter for observation and analysis since one could easily observe flow dynamics and interaction in the model. Only if the fluid is transparent can one visualize the mode of flow in the channel and assess the behavior of the vascular devices. It is also helpful for troubleshooting and various subsequent model iterations to gain additional understanding of the model.

In conclusion, density, cost, viscosity, solubility, ease of manufacturing, and transparency are all very significant criteria in choosing the most appropriate blood solution for the calcified vessel model. With these takings into account, much care will ensure that the solution chosen will replicate blood flow adequately, allowing for more reliable data and insight into the practice of vascular interventions.

4.3.5 Blood Vessel Design

The outlined criteria for concept selection of the vessel design considers the QFD requirements of replicability, vessel properties, modeling of simulated use conditions, and cost. First, the design must be replicable. This includes providing a technical data package which includes the CAD model and CAD drawing (dwg) of the design to the client for their effective replication of the design. The design must be simple to manufacture and assemble, while also matching human vessel dimensions and simulating human vessel functions.

The vessel properties of the design are constructed and designed to the customer needs. The opacity property of the vessel design must be close to a value of zero. A value of zero opacity results in complete visual transparency. The vessel design is required to be see-through because the customer must

be able to visualize the deployment of their intervention devices within the vessel model.

The vessel model will be required to hold a fluid pressure, as the model is a closed-loop system. A pulsatile pump will provide the system with a constant pulsatile pressure that the vessel will need to be able to withstand. The blood analog pressure will simulate that of the arteries within an individual who has peripheral artery disease. The blood analog pressure the team aims to design for is 200 mmHg systolic pressure, which is converted to Pascals by multiplying the mmHg value by 133.3, resulting in approximately 26.7 kPa. An analysis of the blood substitute pressure and yield strength of the vessel model was done to ensure there would be no potential plastic deformation of the vessel model.

The design of the calcified vessel model must model simulated use conditions. This is in context to real blood vessels with PAD, and the actual flow rates, pressures, and shear stresses found within them. The pump system that the team is implementing will replicate the actual heart with a pulsatile pump. This pump will operate on a cadence close to the pumping of an actual heart. This is a customer need, because the vessel model will be used for testing deployment of arterial intervention devices in real patients. Thus, the calcified vessel model will need to simulate the pump mechanisms found in arteries with PAD.

The cost of manufacturing the vessel model will be important to the overall success of the project. The project has an allocated budget of \$3000, and with that, the team must consider the most cost-effective solutions to the customer and engineering requirements. A balance of quality, functionality and cost reduction throughout the project will be needed to achieve this objective. The scope of the project is to manufacture twelve of these units, so the team will consider vessel design concepts which offer cost reductions in services, required tools, and materials needed for prototyping and production.

4.4 Concept Selection



4.4.1 Top-Level Design

To select the concept of top-level design a simple, weighing of the advantages and disadvantages for each design is considered. This selection is subject to change as the project progresses, since testing will lead to further development of the design. The first concept leads to the lowest head in the system out of the three concepts because the pump is on plane with the artery model. Although it has the least head, this concept does not lead to the best ergonomics since the top of the model will have more components than necessary. Additionally, the electronics are in a location where there is a risk of fluid ruining them. The second concept fixes the ergonomics issue; however, it has the greatest head out of the three designs. This design also puts the electronics in harm's way since they are next to the blood analog tank. The third concept combines the best aspect of both previous, as well as keeping the pump out of the way of potential fluid from failure. This design leaves only the artery model atop the cart and has minimal head since the pump is near the same level as the artery model. With the advantages and disadvantages listed above, the top-level design concept that best fits the deliverables of the project is the third concept shown in Figure 9 in Section 4.2.1 of this report.

4.4.2 Calcified Lesion Material

The design concepts for calcified lesion materials were selected based on evaluation by a specification table. This specification table is shown below in Table 1. It compares each design concept across the project's engineering requirements of lesion hardness, resolution, and cost. Designs were judged on the proximity of their values within these three criteria to their corresponding target values. Criteria considered more important to the overall success of the project were weighted more heavily in the selection process, as shown on the project QFD.

Table 5 – Calcified lesion material specification table

Material -	3D Printer Filament	Fired Ceramic	Steel
Target			
Hardness: Shore 39D	Shore 39D	Shore 44D	Shore 33D
Resolution: ~0.01 mm	0.1 mm [10]	~1 mm	0.01 mm [11]
Cost: \$0	\$40/kg + manufacturing	\$7/kg + manufacturing	\$14/kg + manufacturing

Design concepts could not be compared to benchmarked designs because none feature modeled calcified lesions. Modeling arterial calcified lesions is a novel feature within nonbiological blood vessel models, and so the generated design concepts could only be compared to each other.

According to the project’s customer requirements, 3D printer filament and fired ceramic best model simulated use conditions, 3D printer filament and steel are the most replicable, and steel is the most durable. According to engineering requirements, 3D printer filament most accurately and consistently models lesion hardness, 3D printer filament and steel offer the highest resolution, and fired ceramic is best in terms of lowest material costs.



Ultimately, the 3D printer filament design concept was chosen as the calcified lesion material due to its high scores in the criteria of replicability, accurate modeling of simulated use conditions, high resolution, and desired lesion hardness. The material cost of filament was the highest of all design concepts, but the manufacturing costs of the other design concepts were estimated to be even greater. Overall, the 3D printer filament design concept scored highest within the highest-weighted relevant customer and engineering requirements, and thus is considered the best calcified lesion material concept for contributing to the success of the calcified vessel model.

Product images and cost estimates were provided by www.amazon.com.

4.4.3 Calcified Lesion Adhesion Method

The design concepts for calcified lesion adhesion method were selected based on evaluation by a specification table. This specification table is shown below in Table 2. It compares each design concept across the project’s engineering requirements of lesion adhesive strength, dimensions, and cost. Designs were judged on the proximity of their values within these three criteria to their corresponding target values. Criteria considered more important to the overall success of the project were weighted more heavily in the selection process, as shown on the QFD.

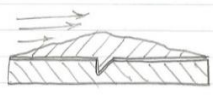
Table 6 – Calcified lesion adhesion method specification table

Adhesion Method -	Adhesive Paste/Tape	Interlocking Mechanism	Embedded Lesion
Target			

Adhesive Strength: >3 Pa	>27 Pa	>27 Pa	(Yield strength of vessel wall)
Dimensions: ~0 mm	0 mm	~1 mm [19]	~0 mm
Cost: \$0	\$0.72/mL of paste or \$1.90/m of tape	Negligible	Negligible

Design concepts could not be compared to benchmarked designs because none feature modeled calcified lesions. Modeling arterial calcified lesions is a novel feature within nonbiological blood vessel models, and so the generated design concepts could only be compared to each other.

According to customer requirements, the adhesive paste/tape best models simulated use conditions, the interlocking mechanism is the most replicable, and the embedded lesion is the most durable. According to engineering requirements, the adhesive paste/tape and the interlocking mechanism most accurately and consistently model lesion adhesive strength (embedded lesion adhesive strength cannot be controlled), the adhesive paste/tape and embedded lesion have no protruding/intruding dimensions, and the interlocking mechanism and the embedded lesion are best in terms of lowest additional material costs.

Ultimately, the adhesive paste/tape was chosen as the calcified lesion adhesion method due to its high scores in the criteria of accurate modeling of simulated use conditions, lack of protruding/intruding dimensions, and desirable adhesive strength. The material cost of adhesive paste/tape was the highest of all design concepts, but its total cost was considered relatively small compared to the total budget. Overall, the adhesive paste/tape design concept scored highest within the highest-weighted relevant customer and engineering requirements, and thus is considered the best calcified lesion adhesion method concept for contributing to the success of the calcified vessel model.

Product cost estimates were provided by www.amazon.com.

4.4.4 Blood Analog



Material:	Glycerin	Simulated Blood	Corn Syrup, Water, Flour Mix
Specification Requirements:			
Density	1.26 g/mL	1.043-1.060 g/mL	Corn syrup- 1.37 g/mL (adjusted with water)
Cost	\$60	\$33	\$10
Viscosity	934 cP	N/A but states similar	Made to ideal
Solubility	High	Soluable	Good
Transparency	Yes	No	Yes mostly
Manufacturing	Pre-made	Pre-made	Mix ourselves

Figure 26 - Concept Selection Criteria

In the quest for an optimal blood analog for the calcified vessel model, three leading candidates were thoroughly evaluated based on established criteria: glycerin, corn syrup-water-flour mixture, and simulated blood. Each option was scrutinized for its strengths and weaknesses concerning their density,

cost, viscosity, solubility, ease of manufacturing, and transparency.

Glycerin is a transparent, non-biological substance known for its low toxicity and wide availability. One of its most significant advantages is its density, which is relatively close to that of human blood, allowing for an accurate simulation of physiological conditions within the model. This similarity is crucial when assessing the performance of vascular devices, as any discrepancies in density could lead to inaccurate conclusions about device effectiveness. Glycerin's transparency also facilitates direct observation of fluid dynamics within the model, enabling researchers to visualize interactions between the blood analog and the vascular devices in real time. This visibility is invaluable for troubleshooting and refining experimental setups, as it allows for immediate identification of anomalies in fluid behavior. However, glycerin does have a higher price compared to other options, which could strain the project budget. Additionally, while Glycerin is relatively safe to handle, it does necessitate adherence to established safety protocols, which, while manageable, add a layer of complexity to its use.

The corn syrup-water-flour mixture represents a more cost-effective and customizable alternative. The team can easily modify the proportions of these ingredients to adjust the viscosity and flow characteristics of the solution, tailoring it to meet specific experimental needs. This adaptability is particularly advantageous for experiments that require precise control over fluid properties. However, the preparation of this mixture can be time-consuming, as it involves careful mixing and ensuring the right consistency. Additionally, the mixture's stability poses concerns; it may harden over time, which could compromise its accuracy and consistency in simulating blood flow. This variability could lead to challenges during experimentation, requiring researchers to constantly monitor and adjust the solution.

Simulated blood is engineered to closely mimic the viscosity and flow properties of real blood, making it an attractive option for accurately representing biological conditions. This close resemblance helps in providing reliable data when evaluating the performance of vascular devices. However, a significant drawback of simulated blood is its opacity, which hinders visibility during experiments and complicates the observation of internal processes. This limitation could restrict the ability to analyze interactions effectively, making it difficult to troubleshoot issues or validate findings. Furthermore, the absence of standardized safety guidelines for handling simulated blood means that researchers must undertake their own safety assessments, introducing an element of uncertainty and potential risk.

After careful consideration of the three options, glycerin emerged as the most suitable blood solution for the calcified vessel model. Its transparency and density closely match those of blood, providing a robust platform for accurately simulating blood flow and facilitating direct visualization of vascular device interactions. Despite its higher cost and the need for safety precautions, glycerin's benefits significantly outweigh its drawbacks. The ability to observe fluid dynamics in real time enhances the understanding of how devices function within the vascular system, contributing to the project's objective of optimizing vascular interventions and improving patient outcomes. Glycerin's non-biological nature also reduces contamination risk and ethical concerns, making it a practical choice. While other options such as simulated blood and corn syrup mixtures have merits like lower cost and customizable properties, their lack of transparency and consistency renders them less effective for direct observation and analysis. Glycerin strikes a balance between transparency, ease of use, and safety, ensuring the collection of reliable, reproducible data essential for advancing research and development in the field of vascular care.

4.4.5 Blood Vessel Design

The blood vessel design concepts were selected based on evaluation of the QFD and applying its customer needs and engineering requirements to each design concept. To help in the evaluation process, a table is used to visualize the best design based on qualitative comparisons to selection criteria. The criteria used in the table are related to the QFD, either engineering requirements or customer requirements. Yes and/or no answers of whether each concept effectively meets a certain criterion are used in the table to provide direction to the best concept. The best concept will be cost-effective, simple to

manufacture for cost purposes and model simulated use-conditions.

Table 7 – Blood vessel design concept evaluation

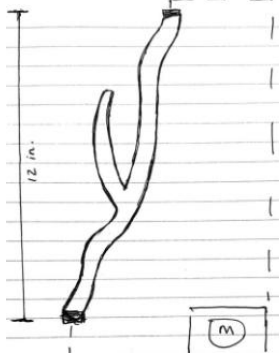
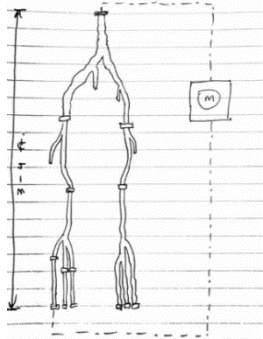
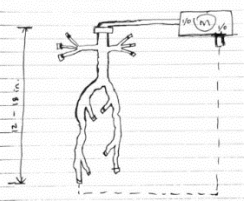
<u>Vessel Design Structure</u>	Femoral Artery (R)	Lower Extremity	Femoral Artery
			
Customer Needs	Yes	No	Yes & No
Time Constraint	No	Yes	Yes & No
Material Constraint	No	Yes	No
Budget Constraint	No	Yes	No
Achievable	Yes	No	Yes & No

In the vessel design concept evaluation table 7 above, the “Yes” and “No” responses answer to the feasibility and the potential constraints of the different vessel design structures. A “Yes” response is ideal for Customer Needs and Achievability. For Time Constraints, Material Constraints, and Budget Constraints, a “No” response is ideal. No design is perfect at meeting all the team’s ideal responses. However, the table will help clarify the design that best satisfies the customer’s needs, achieves quality, and stays within the team’s budget.

The results presented in this table assisted the team in the selection process, ultimately directing the project towards the right-side (only) femoral artery design. This design meets key criteria, including cost effectiveness, replicability, and realistic simulation used conditions. Additionally, it presents no significant constraints in terms of design or manufacturability. These results suggest minimal production challenges in the future. With consistent progress and active team engagement, there is great opportunity to successfully produce this model, and the project's subsystem lead times can be worked in parallel to one another. Given the project’s seven-month life cycle, it is important the team select a design that is feasible to produce and aligns with the client’s requirements.

4.4.6 Final Design CAD and Flow Diagram

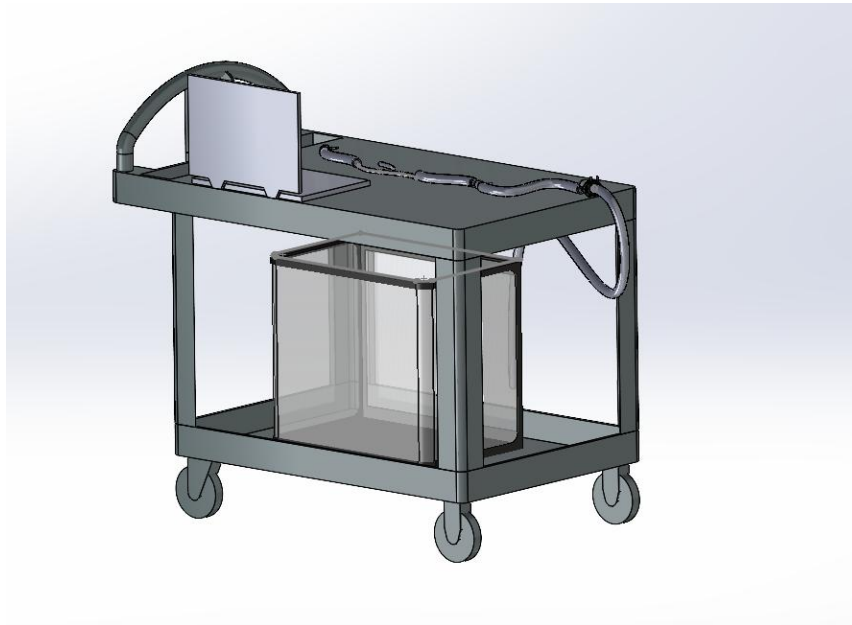

Figure 27 – Final CAD Design for Calcified Vessel Model Assembly

Figure 27 illustrates the team’s final CAD design for the calcified vessel model assembly, created using SolidWorks CAD software. Each component and the full assembly were designed by the team, with the corresponding assembly drawing later in this section. The drawing includes balloon pointers to identify individual components. The CAD assembly consists of the calcified lesion model, vessel model, fluid tubing, pump, pressure transducers, blood substitute reservoir, transportable cart, and data acquisition system. It is important to note that the blood substitute is not represented in the CAD design.

The team’s bill of materials, detailed in Section 5.3 of this report, confirms that all components of the assembly have been purchased and acquired, including the recent arrival of the pressure transducers. While this represents the final CAD design, the team acknowledges that minor adjustments may be made if necessary to accommodate changes during the assembly process.

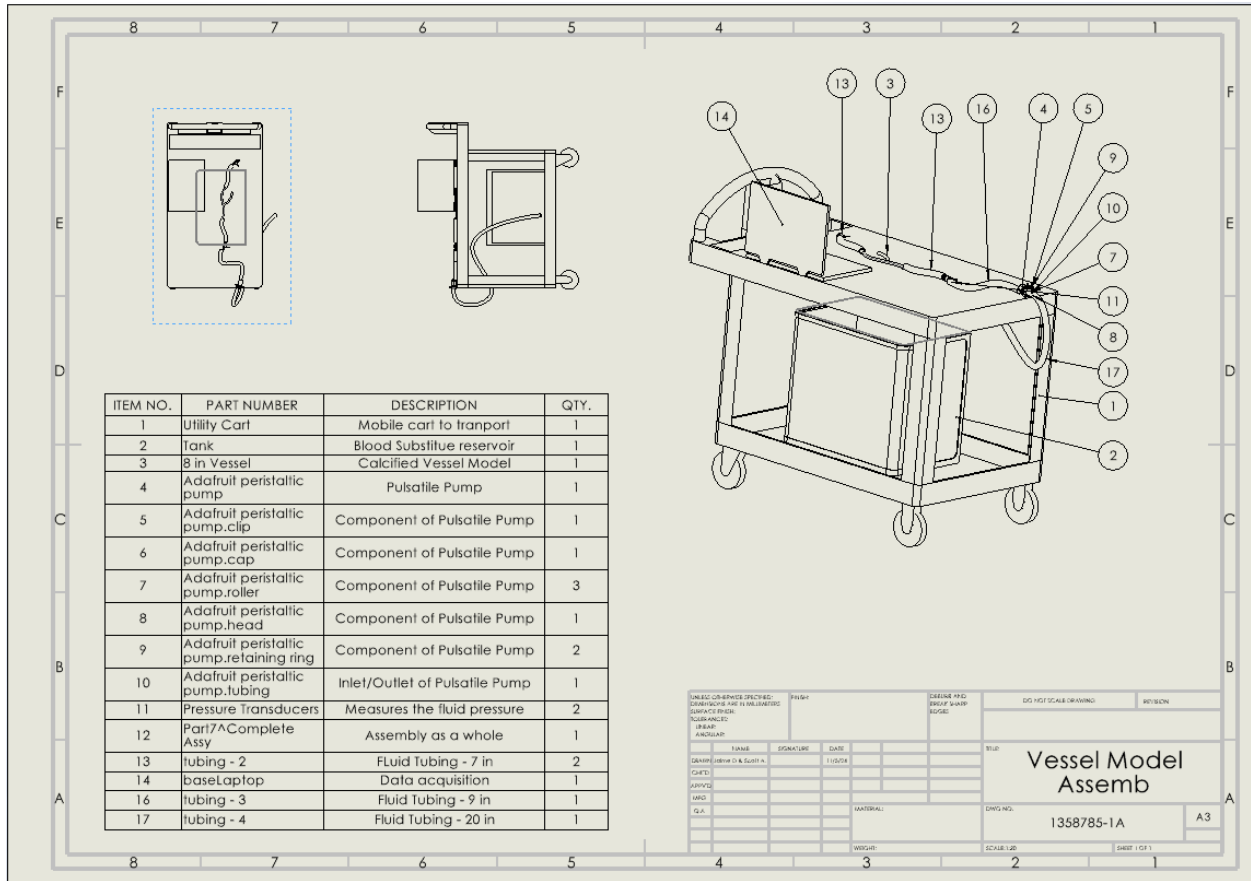

Figure 28 – Final CAD Drawing for Calcified Vessel Model Assembly

Figure 28 presents the team’s final CAD drawing for the vessel model assembly, developed to seamlessly connect design intent with manufacturing execution. The drawing incorporates balloon indicators for clear component identification and adheres to the industry-standard ASME Y14.5, ensuring consistency and professionalism in documentation. By linking each component in the drawing to its corresponding entry in the bill of materials, the team can efficiently monitor kanban inventory and ensure material availability. This approach enhances efficiency, accuracy, and communication throughout the production process. As noted previously regarding Figure 27, minor adjustments to the CAD design may occur based on iterations from the circulation simulation and 3D printing process. This is the team’s final CAD design of the total assembly.

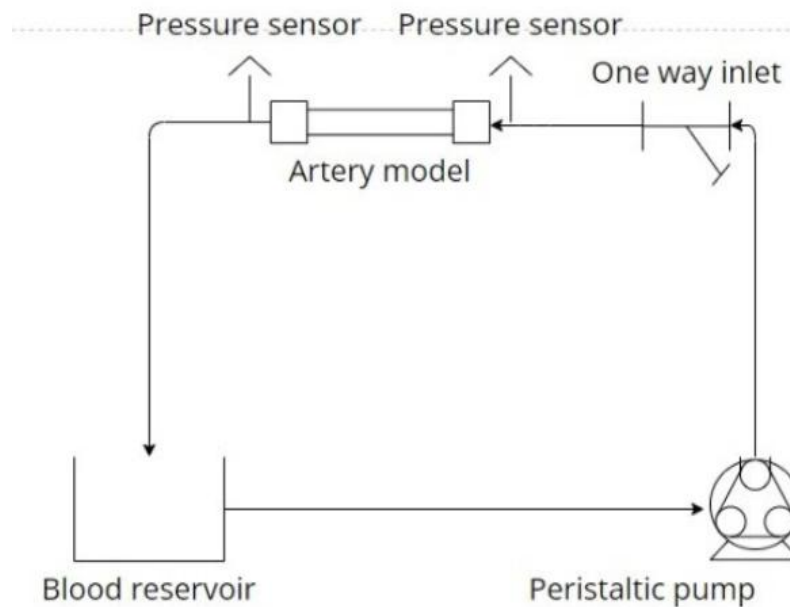

Figure 29 – Pipe Flow Diagram

Figure 29 contains a pipe flow diagram showing the path the fluid takes through the model. The diagram shows the sensors and electronics that it will encounter as it passes through the system. The purpose of this diagram is to allow for the team and the client to better visualize the system and the purpose of specific components, such as the pressure sensors and stent inlet. Below a circuit diagram for the pressure transducers is provided in figure 30. This circuit diagram shows how the sensors are wired to a load cell amplifier chip, then plugged into the Arduino microcomputer. This setup will allow for the team to display the data collected from the system onto an LCD display for the user to see.

Figure 30 – Circuit Diagram for Pressure Transducers

5 Schedule and Budget

This section of the report covers the team’s scheduling and budgeting over the course of the project. Section 5.1 shows the team’s detailed Gantt chart for the first semester, including their work-breakdown-schedule and a description of each task) and a draft of the team’s Gantt chart for the second semester. Section 5.2 shows the team’s total project budget, including prototyping, final design build, travel, and any other expenses. Section 5.3 shows and discusses the team’s Bill of Materials for one unit of their final design concept, including details such as cost, material(s), purchased or manufactured part, vendor, vendor part number, manufacturer number, lead time, and more.

5.1 Schedule

The team utilized a Gantt Chart throughout the project to date, which is detailed further in this schedule section through a visual. The Gantt chart allowed the team to break the project into smaller, more manageable tasks, aiding in organizing and defining the overall project scope. All components of the Gantt chart align with the project scope, ensuring no deviations. The primary objective has been to stay on schedule and avoid delays within the project timeline.

Each team member managed specific tasks and sub-tasks within their assigned subsystems, while certain major tasks required the project group's attention and responsibility of the entire team. These collaborative efforts are identified within the Gantt Chart. This project management tool has been

instrumental in the team’s success, ensuring assignments and project deliverables remain on track.

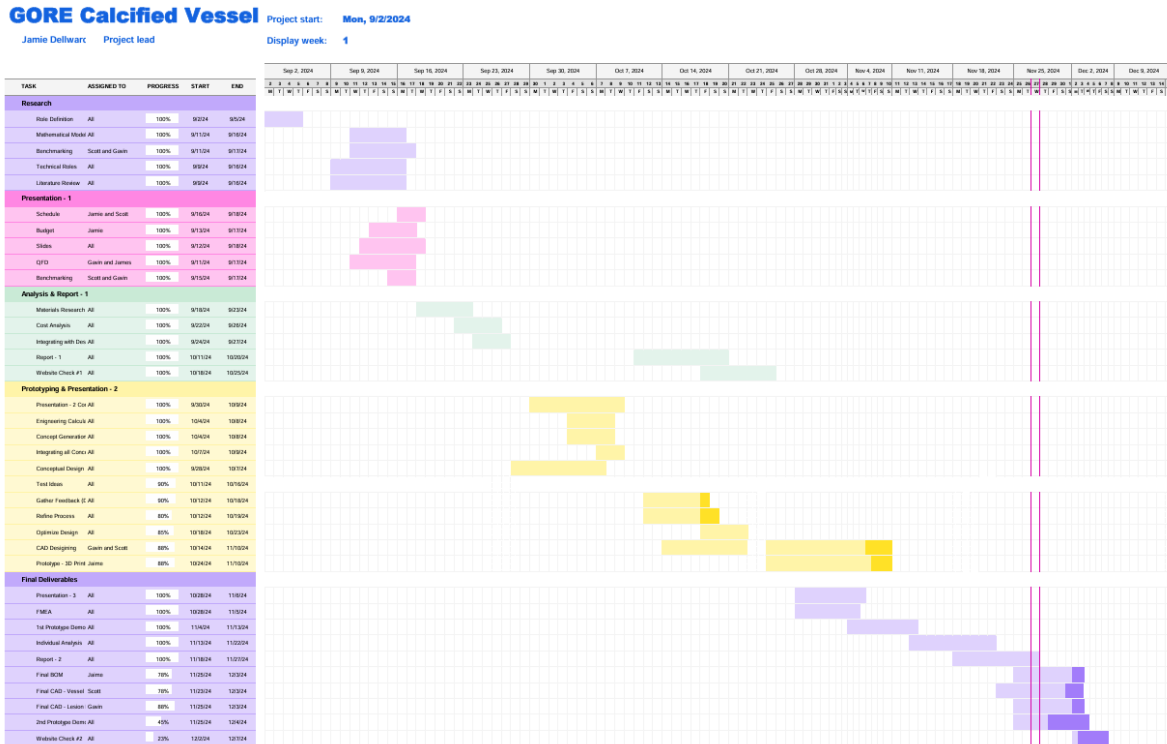

Figure 31 – Gore Calcified Vessel Team – Gantt Chart Fall Semester 2024

Figure 30 presents the Gantt chart for the first semester of Mechanical Engineering Design class, ME 476C. It outlines tasks, sub-tasks, project deliverables, and milestones in sequential order, serving as a roadmap for the team’s progress and planning. The semester is divided into five sections, each color-coded for clear distinction. These sections represent key milestones in the project: Research, Presentation 1, Analysis & Report 1, Prototype Stage & Presentation 2, and Final Deliverables. Each section includes specific tasks aligned with its respective milestone. The team is approaching the end of the semester, with only the finalization of CAD models, the second prototype demonstration, and the final review of the semester’s website remaining to be completed. As shown above in Figure 30, the red vertical lines indicate the team’s current progress, which is tracked using the dates displayed along the top of the Gantt chart.

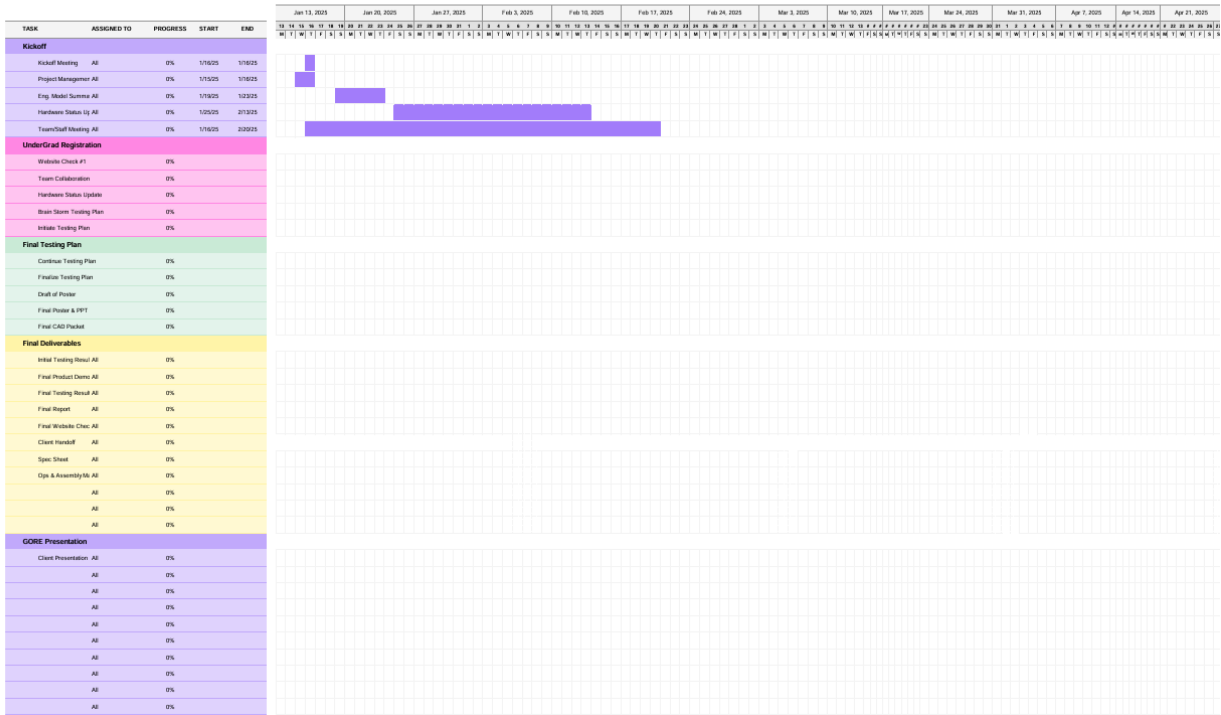

Figure 32 – Gore Calcified Vessel Team – Gantt Chart Spring Semester 2025

Figure 32 shows the team’s first rough draft of their Gantt chart for the upcoming spring 2025 semester. The Mechanical Engineering Design class is a two-semester class. Spring 2025 is the final semester for the team to achieve their project intent and deliver their product to their client. The semester starts off with the Kickoff section which includes initial startup tasks. Tasks that involve being collaborative with the team and realigning each other's agenda to meet the team's goals once again. Following this section is the Undergraduate Registration. In this section the team will initiate testing plans by first brainstorming ideas and collaborating with the team’s client. Final testing plan and Final deliverables are the two final sections. In these sections the team will finalize all components of their technical data package that include their final testing plan, final CAD models and drawings, final spec sheet, and final operations and assembly manual. Along with the team’s final technical data package will be final presentations, demonstration, and client presentation.

5.2 Budget

Table 8: Current State of Budget

GORE Calcified		Income	\$3,000	
		Fundraising	\$800	
		Total Income	\$3,800	
Item	Quantity	Price/Per	Total	Notes
Pump	1	\$ 28.43	\$ 28.43	Purchased
Variable Power Supply	1	\$ 54.03	\$ 54.03	Purchased
85A Filament	1	\$ 56.15	\$ 56.15	Purchased
SainSmart TPU	1	\$ 53.78	\$ 53.78	Purchased
Tubing	2	\$ 7.63	\$ 15.26	Purchased
Cart/Platform	1	\$ 94.50	\$ 94.50	Purchased
Tank	1	\$ 46.39	\$ 46.39	Purchased
Arduino	1	\$ 45.00	\$ 45.00	Purchased
Lesson Adhesive	2	\$ 5.19	\$ 10.37	Purchased
One way Inlet	1	\$ 9.86	\$ 9.86	Purchased
Artery Stand	1	\$ 16.38	\$ 16.38	Purchased
Blood Analog	1	\$ 36.30	\$ 36.30	Purchased
Syringes	100	\$ 0.16	\$ 16.37	Purchased
Wash and Cure Kit w/ Sealed Container	1	\$ 193.20	\$ 193.20	Not Yet
50A Resin	1	\$ 200.00	\$ 200.00	Not Yet
Pressure Transducer	25	\$ 11.03	\$ 275.75	Purchased
2pc Microcontroller	5	\$ 8.25	\$ 41.24	Purchased
AnyCubic Photon Mono 5S Pro	1	\$ 299.00	\$ 299.00	Purchased
UV curing light	1	\$ 23.39	\$ 23.39	Purchased
Flow Sensor	2	\$ 10.36	\$ 20.72	Purchased
55D TPE Filament	1	\$ 25.99	\$ 25.99	Purchased
40D TPU	1	\$ 56.15	\$ 56.15	Purchased
Vessels	12	-	-	On Going
		Spent	\$1,618.26	
		Total Budget Remaining	\$2,181.74	

The budget for this project includes expenses related to prototyping, final design build, and material procurement, with a focus on ensuring the quality and functionality of the calcified lesion models. Significant allocations are directed toward essential components such as pressure transducers, flow sensors, and 3D printing materials, which are critical for replicating realistic arterial conditions. Additional costs cover items like curing stations and 50A resin for structural reinforcement, as well as software tools and hardware needed for testing and validation. The budget is designed to support each stage of the project, from iterative prototyping to final model production, while maintaining a balance between cost-effectiveness and achieving high precision and durability in the models.

5.3 Bill of Materials (BoM)

Table 9: Current Bill of Materials

Item	Quantity	Price/Per	Total	Purchased/Manufactured	Vendor	Lead Time
Pump	1	\$ 28.43	\$ 28.43	Purchased	Amazon	3 Days
Variable Power Supply	1	\$ 54.03	\$ 54.03	Purchased	Amazon	3 Days
85A Filament	1	\$ 56.15	\$ 56.15	Purchased	Amazon	3 Days
SainSmart TPU	1	\$ 53.78	\$ 53.78	Purchased	Amazon	3 Days
Tubing	2	\$ 7.63	\$ 15.26	Purchased	Home Depot	1 Day
Cart/Platform	1	\$ 94.50	\$ 94.50	Purchased	Harbor Freight	1 Day
Tank	1	\$ 46.39	\$ 46.39	Purchased	PetSmart	1 Day
Arduino	1	\$ 45.00	\$ 45.00	Purchased	Amazon	2 Weeks
Lesson Adhesive	2	\$ 5.19	\$ 10.37	Purchased	Amazon	3 Days
One way Inlet	1	\$ 9.86	\$ 9.86	Purchased	Amazon	2 Weeks
Artery Stand	1	\$ 16.38	\$ 16.38	Manufactured	In House	1 Week
Blood Analog	1	\$ 36.30	\$ 36.30	Purchased	3B Scientific	3 Weeks
Syringes	100	\$ 0.16	\$ 16.37	Purchased	Amazon	2 Weeks
Wash and Cure Kit w/ Sealed Container	1	\$ 193.20	\$ 193.20	Purchased	AnyCubic	2 Weeks
50A Resin	1	\$ 200.00	\$ 200.00	Purchased	Amazon	2 Weeks
Pressure Transducer	25	\$ 11.03	\$ 275.75	Purchased	Utah Medical	3 Weeks
2pc Microcontroller	5	\$ 8.25	\$ 41.24	Purchased	Amazon	2 Weeks
AnyCubic Photon Mono 5S Pro	1	\$ 299.00	\$ 299.00	Purchased	AnyCubic	2 Weeks
UV curing light	1	\$ 23.39	\$ 23.39	Purchased	Amazon	1 Week
Flow Sensor	2	\$ 10.36	\$ 20.72	Purchased	Amazon	2 Weeks
55D TPE Filament	1	\$ 25.99	\$ 25.99	Purchased	Amazon	2 Weeks
40D TPU	1	\$ 56.15	\$ 56.15	Purchased	Amazon	3 Weeks
Vessels	12	-	-	Manufactured	In House	On going

The Bill of Materials (BoM) for the ongoing vessel modeling project is still under development, reflecting the dynamic and iterative nature of the design and manufacturing process. Key components include pressure transducers, flow sensors, and tubing, which are vital for replicating realistic arterial conditions and evaluating device performance. The vessels, which are being manufactured in-house, remain a work in progress, ensuring they meet the specifications required for accurate testing of calcified lesions. Some items, such as the cure station and 50A resin, are in the process of being ordered, as they are critical for the curing and structural reinforcement of fabricated parts. As the project advances, additional materials and equipment may be identified and incorporated into the BoM to address unforeseen challenges or enhance the functionality of the models. The current state of the BoM highlights its evolving nature, emphasizing careful planning and adaptability to meet the project's goals effectively.

6 Design Validation and Initial Prototyping

This section of the report covers the team's validation of their final design concept and their initial prototyping of two subfunctions of their final design concept. Section 6.1 discusses the team's failure modes and effects analysis (FMEA), including critical potential failures and how their design mitigated those failures, and the risk-tradeoff assessment they have performed. Section 6.2 contains subsections for each of the two initial prototypes, including the question the team tried to answer with the prototype, the answer to that question, and how it influenced the design or plans for further iterations. Section 6.3 summarizes all engineering calculations performed since the concept selection phase. Section 6.4 briefly summarizes some potential testing procedures that could be completed in the future.

6.1 Failure Modes and Effects Analysis (FMEA)

Product Name		Development Team				Page No 1 of 1			
System Name		James Anteau, Gavin Lazurek, Jamie Delwardt, Scott Alex				FMEA Number 1			
Subsystem Name						Date 11/6/2024			
Component Name									
Part # and Functions	Potential Failure Mode	Potential Effect(s) of Failure	Severity (S)	Potential Causes and Mechanisms of Failure	Occurance (O)	Current Design Controls Test	Detection (D)	RPN	Recommended Action
Power supply	Power Surge	Pump motor failure	10	Power supply failure	1	Thoroughly test the power supply	1	10	Select new power supply if first is faulty
	Shortage due to fluids	Fry electronics	10	Failure in other systems	3	Test system with protection of electronics	2	60	Ensure the layout of the final design minimizes the risk of fluids coming in contact with this circuit
Pump	Airlock	Loss of pump function	7	Air trapped in piping system	5	Test system and priming procedure multiple times to see if an airlock occurs	3	105	Redesign pump priming system
	Motor failure	Loss of pump function, and potential permanent failure	7	Surge from power supply	1	Test system to see if power can exceed limit	4	28	Install breaker into system
	Pressure variation from improper voltage	Inaccurate pressure or tubing failure	4	Incorrect input from power source	1	Test operations of model	5	20	Create detailed instructions so the user can avoid this error
Connector tubing	Decoupling	Flow will stop and fluid will spray from the failure point	10	Tubing could decouple from pressure	3	Test the system above the expected pressure range	2	60	Rethink coupling choice
Vessel stand	Manufacturing issue	Vessel model will be unstable	6	3D printing defects	1	Test visually while system is operating	1	6	Evaluate for improvements and refine design
Vessel model	3D print error	Vessel model will not hold the fluid pressure	10	3D printing defects	1	Test visually with a water flow system prior to implementing into the blood substitute system	1	10	Optimize for a watertight design adding fillets and chamfers at corners to reduce stress concentration in those areas
	Rupture from pressure	Vessel model will leak and not hold pressure	10	3D printing defects	1	Test visually with a water flow system to ensure an air tight seal is present.	1	10	Use post-processing methods like sealant material and allow for adequate curing times
Pressure sensors	Uncertain readings	Uncertainty is outside acceptable range	2	Human, calibration, device malfunction, reading	3	Test with calculations	1	6	Have a predicted value range before testing to make sure number is reasonable
	Pressure range exceeded	Sensor will break, potential fluid	7	Pump failure could lead to this failure.	2	Test pressure sensors with the pressure range used	3	42	Select new pressure transducers if necessary
Arduino module	Soldering defects	The load cell amplifier chip will not work	5	Frying the chip while soldering is quite common	5	Test the sensor and chips after soldering.	1	25	Make sure to test for functionality of the sensors before installation.
	Exceeds current capabilities	Arduino unit will be fried and unusable	5	If input power for Arduino exceeds its operating range	2	Test operations of model	5	50	Ensure the re are safety measures in place to keep this from occurring
Flow sensor	Uncertain readings	Uncertainty is outside acceptable range	2	Human, calibration, device malfunction, reading	3	Test with calculations	1	6	Have a predicted value range before testing to make sure number is reasonable
	Unintentional build up	Flow sensor will not work	4	Sediment in blood mixture	3	Test the blood solution for any large particles before use.	1	12	Strain blood solution before use
Blood tank	Hose decoupling from tank	Fluid would pour out of tank onto the cart	9	Hose not secured correctly to the tank	3	basic testing of the system will show the failure	1	27	Rethink coupling choice
Lesion model	Separation from vessel model	Ejection of lesion model, partial obstruction of fluid flow	6	Low substrate surface energy, improper surface preparation	3	Testing an adhered lesion can withstand its maximum expected shear force	2	36	Select an adhesive compatible with substrates; improve surface preparation procedures
Cart	Breaking	Damage electronics and model if it collapses	5	Joints disconnect, wheels break, water damage	1	Inspect cart before use	1	5	Inspect cart before use, build ourselves
	Water Compromised	Ruin electronics	6	Water overflow, disconnected tubing, leak in vessel	3	Test other systems	1	18	Keep electronics in safety box, inspect all components before each test

Figure 33 – Failure Modes and Effects Analysis

From the FMEA, the failure mode with the greatest RPN number is an air lock within the pump. This occurs when an air pocket finds its way onto the pump through the tubing. The air lock will cause the pump to have reduced performance due to the compressible air in the system. This would result in the system failing to simulate the proper conditions encountered in the peripheral arterial system. This issue is easily resolved, the user must re-prime the pump system to rid the pump of the air pocket.

The next important failure mode found in the FMEA is the development of pressures higher than the model can withstand. There are multiple potential ways this can occur such as a blockage caused by debris traveling through the system, a kink in the tubing, or a pump malfunction. The resultant high pressure could cause the vessel to rupture, or tubing joints to separate. This would allow for fluids to escape the system and potentially contact the electronics of the model. To mitigate this issue the team will test the vessels and tubing joints at pressures exceeding the usual pressures encountered within the system to ensure they can withstand higher pressures. Additionally, the team will ensure the lesion within the model does not come loose and lodge in the tubing, as well as implementing a filter over the pump intake to avoid debris entering the system.

Another critical potential failure of this design is an adhesive failure of the bond between the calcified lesion model and vessel model. This would result in the separation of the lesion model from the vessel model, leading to either an ejection of the lesion model from the vessel model or a lodging of the lesion model inside the vessel model. An adhesive failure can occur if an improper adhesive is used to bond the materials of both substrates and/or if inadequate surface preparation procedures were used, resulting in a reduction of the adhesive strength of the bond to less than that of the target value for this application. The current design controls test for this failure mode is to manually apply the maximum expected shear force of this application to the bonded calcified lesion model to ensure that the bond is strong enough to withstand its simulated use conditions. To prevent such failures, the team recommends selecting an adhesive designed for bonding flexible photopolymer resin and high-hardness TPU substrates, such as cyanoacrylate adhesives, and improving surface preparation procedures by wiping with a clean solvent and/or abrading with a clean fine abrasive [57].

6.2 Initial Prototyping

6.2.1 Vessel/Lesion Prototype

The vessel/lesion prototype aims to replicate the properties of a human femoral artery as close as possible. The vessel's wall thickness, diameter, surface quality, and flexibility are among the main considerations for determining the success of this prototype. These properties will be judged by the project's customer requirements from the QFD. This prototype also aims to answer the question of whether the vessel model and lesion model substrates will successfully form an adhesive bond to each other with a selected adhesive. In this application, "success" is defined as withstanding the simulated use conditions of the Calcified Vessel Model without adhesive failure.

The vessel and lesion models were manufactured using 3D printing of SainSmart Flexible TPU Filament via an Ender 3 V3 KE 3D printer, and of Anycubic Standard Resin via an Anycubic Photon Mono 5S Pro. However, the team plans to use an eco-friendly flexible resin to 3D print their final design. The vessel and lesion models were adhered to each other using Gorilla Super Glue. After preparing both surfaces with an alcohol wipe, a thin glue layer was applied between surfaces, and they were pressed together for ~45 seconds. This allows the adhesive to set on clean surfaces so that it may achieve its maximum bonding strength [58].



Figure 34 – Adhesive Application Equipment



Figure 35 – Lesion Model Adhered to Vessel Model

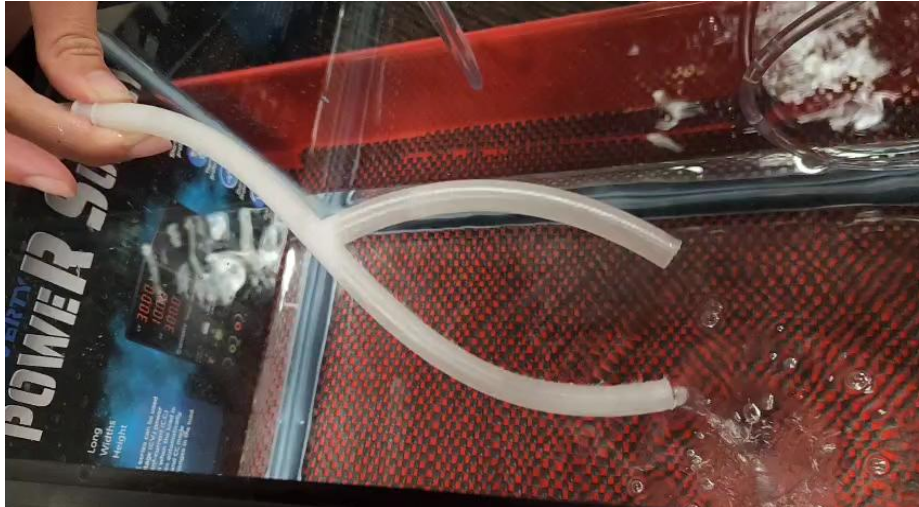

Figure 36 – Vessel/Lesion Model Water Flow Test

This prototype revealed that the TPU-printed vessel models were most accurate to the properties of a human femoral artery of all the models made. TPU vessels are flexible like real arteries, have the correct diameter, and are watertight (in most iterations). However, the resin-printed vessel model maintains a wall roughness accurate to real arteries. With further testing, the resin vessels will achieve the desirable characteristics of the TPU vessels, as well. Additionally, the Gorilla Super Glue formed a “successful” bond between surfaces, withstanding a constant flow of water through the vessel model for long enough to gather useful data. However, the gaps between surfaces made adhesion difficult, and there were concerns about the long-term durability of the adhesive bond regarding its yield strength and water resistance.

Based on the results, an eco-friendly flexible resin will be used for future vessel models, and more iterations of resin prints will help to isolate the issue with collapsing of the vessel. There will also be further testing with wall thickness variation and vessel size to meet the customer requirement of 12 varying models. The results also suggested that a more suitable adhesive for an application with gaps between surfaces, plastic substrates, and water exposure was necessary. Thus, the team has purchased a cyanoacrylate adhesive with a high viscosity for gap-filling, optimized for bonding to plastic and rubber substrates, and that is 100% waterproof [59].

6.2.2 Arduino/Sensor Prototype

This prototype aims to answer the question of whether the Arduino kit and flow rate sensor is successful in its ability to collect data relevant to the team's research objectives. The system operates as a closed-loop setup that includes a pump, an Arduino kit, a calcified lesion vessel assembly, fluid tubing and connectors, and a flow rate sensor. In this stage, the team’s primary focus is on data collection from the flow rate sensor, specifically to measure the volume of liquid moving through the system and to monitor the flow velocity or flow rate of the blood substitute. "Success" is defined as the system outputting the correct data. To achieve this, the team started by having a pump hooked up to a variable power supply. The pump is driven by a DC motor, so the pump is operated at a constant voltage to provide a consistent flow rate. Once this is done a bucket timer test is performed to find the flow rate coming from the pump. Then the flow rate sensor is installed into the system and measures the flow rate from the pump. The values from the flow sensor are then compared to the values calculated from the bucket timer test.

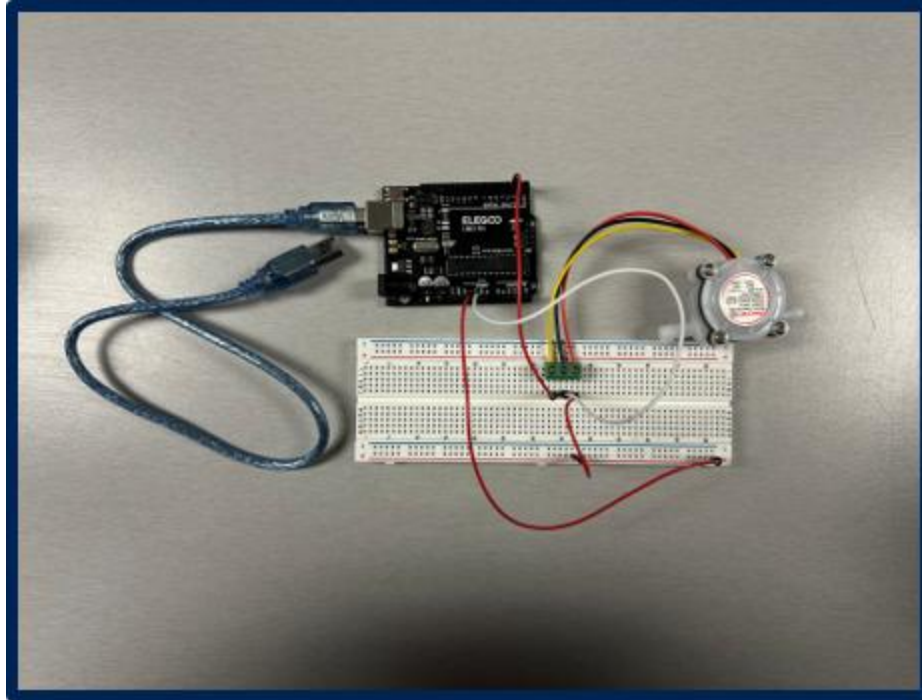

Figure 37 – Flow sensor circuit

After the prototype was constructed and tested, the team found that the flow rate from the sensor is close to the calculated flow rate from the pump. The value is off by less than 50 mL/min. This margin of error is more than the team is willing to accept. This means that the team must make some more effort in creating a code for the Arduino that will yield a more precise reading. The next iteration of the code corrected the issue which led to inaccurate data collection. This means that the team has successfully collected accurate data from a system very similar to the final design to be implemented in the project.

6.3 Other Engineering Calculations

6.3.1 Blood Analog Recipe (James Anteau)

The first step to developing the blood analog is to find what the target properties are. For the scope of this project, and to aide with other calculations, the team is looking to match the density and viscosity of blood. In a medical journal published by the National Institute of Health, blood is a very dynamic fluid that as different viscosities dependent on where they flow within the body, however most textbooks refer to the viscosity of blood to be within 3.5- 5.5 centipoise. [73] For the use of prototyping the model, this range will be acceptable as it is a good average viscosity encountered within the body. The density of blood is a more standard value with Science Direct stating that the density of blood is slightly higher than that of water, with a value of 1060 kg/m^3 . [74] These are the target values that the team will strive to achieve with the blood analog.

After the target viscosity and density are found the next step is to decide how to test the potential analog fluids for these values. Some discussion with Dr. willy, and some quick research led the team to implementing a ball drop test. Where a ball of known mass and volume is dropped through a tube full of the liquid being tested. The time the ball takes to go through a set distance of the fluid is used to calculate the velocity of the ball in the liquid. This is then run through an equation, which includes the density of the fluid, which yields the viscosity of the potential blood analog. This is shown in equation (12) below, note that the unit for this viscosity is Pa*s.

$$\text{Viscosity} = \frac{2(p_s - p_l) * g * a^2}{9 * v} \quad (12)$$

Where p_s and p_l are the densities of the ball and the liquid respectively, g is the acceleration due to gravity, a is the radius of the ball, and v is the velocity of the ball through the liquid. The density of the ball and liquid are found via dividing the mass by the volume occupied. This is shown in equation (13a), and (13b) below.

$$p_s = \frac{m_s}{V_s} \quad (13a)$$

$$p_l = \frac{m_l}{V_l} \quad (13b)$$

The velocity of the ball is calculated by averaging 3 times found by doing 3 trials of the ball drop test. Then the distance the ball traveled through the liquid is divided by the average time. Equation (3) shows the velocity calculation.

$$v = \frac{d}{t_{av}} \quad (14)$$

Where t_{av} is the average time taken to travel d distance through the fluid.

The other property tested in the fluid is the density, which is conveniently necessary for the viscosity calculation. So, the p_l value calculated in equation (13b) will be used for comparison with the target density.

After the density and viscosity for the first potential are calculated, they are compared to the target values. If the viscosity does not match the target value, the quantity of corn syrup in the next iteration of the mixture will be adjusted and the new fluid will be run through the same test and calculations. This process will be repeated until the viscosity of the blood analog is within the target range, and the density is within an acceptable range as well.

To complete the above calculations an accurate way to measure the time traveled through the fluid is necessary. To achieve this a rigid clear plastic tubing along with an endcap was purchased to contain the liquid, and a marble was used as the ball to be dropped; this is all shown in Figure 34 below.



Figure 38 - Ball drop supplies

50 cm was decided to be the distance over which the velocity of the ball will be calculated. Thus, two marks were placed on the tube 0.5 m apart. The radius of the marble was measured to be 0.000925 m, and a weight of 0.0061kg, which when plugged into equation a density (2a) a density of $p_s = 2269.3\text{kg/m}^3$ is found. Next the initial blood analog is created. To start the team decided that a mixture of 3 parts water to 1.5 parts corn syrup will be used as a starting point. Once this mixture is created, the mass of 500ml of the

fluid is found using a basic kitchen scale. This was found to be 0.5505 kg, and when plugged into equation (2b) a density of $\rho_l = 1101 \text{ kg/m}^3$ is found. The next step in the test is to put the fluid into the tube shown in figure 1, and to drop the marble through the fluid. To accurately measure the time for the ball to travel through the fluid a slow-motion video of the ball dropping through the tube along with a stopwatch in frame was taken, figure 2 shows a still frame from one of these videos. Then the team can analyze the video and take the time on the stopwatch at the start and end of the 50 cm, the difference of these values is the time the ball took to pass through the 50 cm.

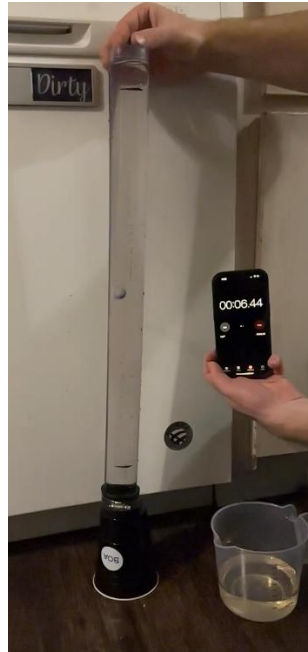

Figure 39 - Video still frame

This video analysis is performed 3 times per fluid then the three times found from this are averaged to increase the accuracy of the results. The times from the first iteration of the fluid are shown in Table 8.

Table 8: Times for Fluid 1

	Trial 1	Trial 2	Trial 3
t_{end} (s)	6.96	3.03	2.11
t_{start} (s)	5.85	1.87	0.96
t (s)	1.11	1.17	1.15

The times from the 3 trials are then averaged to find $t_{av} = 1.14$ s, this is then plugged into equation (14) along with $d = 0.5 \text{ m}$ to yield a velocity of 0.43 m/s . Now that all of the necessary information is found, the viscosity is calculated with equation (1).

$$\text{Viscosity} = \frac{2(2269.3 - 1101) * 9.81 * 0.000925^2}{9 * 0.43} = 0.0051 \text{ Pa} * \text{s}$$

Next the viscosity is converted to centipoise, this turns out to be 5.1 centipoise. This first selection of fluid falls within the target range of viscosity as stated in the calculations section. The density is slightly higher than the target value, however this is not an issue due to the target value of 1060 kg/m^3 being an

average density of blood. At higher viscosities blood is expected to have a slightly higher density. This is all to say that the mixture of 3 parts water to 1.5 parts corn syrup is an acceptable recipe for the blood analog used within the prototyping phase of the calcified lesion model.

After only one iteration of fluid recipes, the mixture of 3 parts water to 1.5 parts corn syrup is determined to be satisfactory in simulating the fluid properties encountered in the human body. The viscosity and density being at the high ends of the acceptable ranges will serve as a worst-case scenario as far as patient properties are concerned. This will allow the team to ensure that the design choices in the prototype will withstand any viscosity and density within the acceptable ranges. Moving forward the team should develop a mixture of the corn syrup and water that will be at the low end of the viscosity and density range to allow for the entire range to be tested. This will further prove that the engineering requirements for simulating the use conditions of the vascular interventional devices will be fulfilled.

6.3.2 SLA Resin Material Properties (Gavin Lazurek)

An analysis on the material properties of stereolithography (SLA) resins was performed to determine their viability for use in manufacturing blood vessel models for this application. First, the engineering strain experienced by the blood vessel model under simulated use conditions was calculated. The goal of the vascular interventional devices to be tested using the calcified vessel model is to restore normal blood flow rates to occluded arteries by expanding the arterial walls. Equation (15) sets the cross-sectional area of the occluded artery with an expanded radius equal to the cross-sectional area of an unoccluded artery.

$$A'_{vessel} - A_{lesion} = A_{vessel} \quad (15)$$

As previously established in Section 4.4.3, the maximum degree of vessel occlusion that will be modeled is 50%. Equations (16-18) represent the cross-sectional areas of the blood vessel with an expanded radius, the calcified lesion, and the blood vessel with a standard radius, respectively.

$$A'_{vessel} = \pi(xr_i^2) \quad (16)$$

$$A_{lesion} = \frac{1}{2}\pi r_i^2 \quad (17)$$

$$A_{vessel} = \pi r_i^2 \quad (18)$$

In these equations, x is the unitless factor by which the arterial radius increases, and r_i is the radius of the internal arterial wall. Solving for x results in a value of $\sqrt{3/2}$, or approximately 1.22. The engineering strain experienced by the blood vessel is defined as the change in length ΔL divided by the initial length L . This change in length occurs about the perimeter of the blood vessel. Equations (19) and (20) represent the perimeters of the blood vessel with an expanded radius and with a standard radius, respectively.

$$P' = 2\pi(xr_i) \quad (19)$$

$$P = 2\pi r_i \quad (20)$$

Equation (21) represents the engineering strain experienced by the blood vessel.

$$\varepsilon = \frac{\Delta L}{L} = \frac{P' - P}{P} = x - 1 \quad (21)$$

For a value of x of ~ 1.22 , the engineering strain results in a value of ~ 0.22 . This value of engineering strain is within the elastic range of two options for SLA resins identified as candidates for use in this application: FormLabs Elastic 50A Resin V2 and FormLabs Flexible 80A Resin. The next step in

this analysis is to calculate the elastic modulus of each SLA resin option. This is done by taking values of engineering stress σ at 50% elongation ($\varepsilon = 0.50$) from their technical data sheets. For that elongation, the Elastic 50A Resin V2 has a stress of 0.9 MPa [60], while the Flexible 80A Resin has a stress of 2.6 MPa [61]. Equation (22) represents elastic modulus.

$$E = \frac{\sigma}{\varepsilon} \quad (22)$$

The elastic modulus of the Elastic 50A Resin V2 is calculated to be 1.8 MPa, while that of the Flexible 80A Resin is calculated to be 5.2 MPa. These values are approximately within the expected range of elastic moduli for blood vessels of 2-6 MPa [62]. The final step in this analysis is to calculate the required internal pressure to expand the radius blood vessel to restore normal blood flow rates. This is done by relating the values of engineering stress and strain applied about the perimeter of the blood vessel to the elastic moduli calculated previously. Equation (23) represents Lamé's equation for the maximum hoop (tangential/circumferential) stress of an internally pressurized thick-walled cylinder, where external pressure is assumed to be zero gauge (atmospheric).

$$\sigma_h = \frac{p_i(r_i^2 + r_o^2)}{r_o^2 - r_i^2} \quad (23)$$

In this equation, p_i is the pressure applied to the internal arterial wall, and r_o is the radius of the external arterial wall. Hoop stress can be used as the value of engineering stress in the calculation of elastic modulus because the material properties of SLA resins are assumed to be isotropic [63]. Equation (24) relates the values of elastic modulus, maximum hoop stress, and engineering strain of this application and solves for p_i .

$$E = \frac{\left(\frac{p_i(r_i^2 + r_o^2)}{r_o^2 - r_i^2}\right)}{x - 1} = \frac{p_i(r_i^2 + r_o^2)}{(x - 1)(r_o^2 - r_i^2)} \rightarrow p_i = \frac{E(x - 1)(r_o^2 - r_i^2)}{(r_i^2 + r_o^2)} \quad (24)$$

The required internal pressure of the Elastic 50A Resin V2 is calculated to be 356 kPa, while that of the Flexible 80A Resin is calculated to be 1030 kPa. These values are within the expected range of internal pressures for this application, where the minimum value is the maximum blood pressure of a human femoral artery of 24.0 kPa [64], and the maximum value is the maximum safe operating pressure of angioplasty balloons of 1620 kPa [65]. Table 9 summarizes the important results of these calculations, as well as the target values by which the viability of an SLA resin option is assessed.

Table 9 – Elastic Moduli and Required Internal Pressures of SLA Resin Options

Resin Option	Elastic Modulus [MPa]	Required Internal Pressure [kPa]
Minimum Target	~2	24.0
Elastic 50A Resin V2	1.8	356
Flexible 80A Resin	5.2	1030
Maximum Target	~6	1620

Based on these results, both SLA resin candidates have been determined to be viable options for use in manufacturing blood vessel models for this application, because their relevant material properties are within the ranges of target values as defined by the engineering requirement of “blood vessel properties” in the project QFD. Thus, a recommendation was made to use either the FormLabs Elastic 50A Resin V2 or the FormLabs Flexible 80A Resin in the SLA 3D printing of the blood vessel model of

this calcified vessel model capstone project, with a preference for the Elastic 50A Resin V2 because it was designed especially for the purpose of modeling soft tissue such as blood vessels [60]. However, if 3D printing with such a low-hardness resin proves difficult, the higher-hardness Flexible 80A Resin may be used, instead.

6.3.3 Data Uncertainty and Flow Rate Analysis (Jamie Dellwardt)

The calcified vessel model hinges on accurate flow rate and uncertainty calculations, which ensure the reliability of data collected during testing. Using the Hagen-Poiseuille equation, flow rate (Q) is calculated based on measured pressure drops (ΔP) and flow resistance (R). Flow resistance is determined by Equation 25.

$$R = \frac{8\mu L}{\pi r^4} \quad (25)$$

where (μ) is the blood analog viscosity, (L) is the lesion length, and (r) is the vessel radius. Using the provided values of $\mu = 3.5 * 10^{-3} Pa * s$, $L = 0.1 m$, and $r = 0.005 m$, the resistance is calculated as $R = 1.426 * 10^8 \frac{Pa}{m^3}$. This resistance represents the flow obstruction caused by the lesion and surrounding vessel geometry. Using the measured pressure drop across the lesion ($\Delta P = 1333.2 Pa$), the flow rate is then derived from Equation 26.

$$Q = \frac{\Delta P}{R} \quad (26)$$

Substituting the known values, the flow rate is calculated as ($Q = 9.35 * 10^{-3} \frac{m^3}{s}$). This flow rate matches physiological benchmarks, confirming that the model can accurately simulate arterial conditions. By analyzing deviations from this baseline, researchers can assess how calcified lesions or device deployments affect blood flow. For example, a significant reduction in flow rate may indicate excessive resistance introduced by the lesion or a malfunctioning device, while higher-than-expected flow rates could signal that the model is not adequately replicating physiological constraints.

In addition to flow rate, uncertainty analysis is critical for validating the precision of sensor measurements. The total uncertainty of the thermocouples (U_T) is calculated using Equation 27, the Root Mean Square Sum (RMSS) method.

$$U_T = \sqrt{(U_{calibration})^2 + (U_{sensitivity})^2 + (U_{response})^2} \quad (27)$$

Using representative values of $U_{calibration} = 0.05 \text{ }^\circ\text{C}$, $U_{sensitivity} = 0.18 \text{ }^\circ\text{C}$, and $U_{response} = 0.15 \text{ }^\circ\text{C}$, the total thermocouple uncertainty is calculated as $U_T = 0.23 \text{ }^\circ\text{C}$. This level of uncertainty is sufficiently low to accurately monitor temperature changes, which directly affect the viscosity of the blood analog. Accurate viscosity measurements are essential for modeling flow resistance and ensuring realistic replication of arterial flow dynamics.

Similarly, the pressure transducers used to measure pressure drops across the lesion are evaluated for uncertainty. The total uncertainty (U_P) is calculated using the RMSS method for pressure, Equation 28.

$$U_P = \sqrt{(U_{calibration})^2 + (U_{sensitivity})^2 + (U_{environmental})^2} \quad (28)$$

Assuming $U_{calibration} = 2.0 \text{ mmHg}$, $U_{sensitivity} = 1.8 \text{ mmHg}$, $U_{environment} = 1.5 \text{ mmHg}$ the total uncertainty is $U_P = 2.37 \text{ mmHg}$. This level of precision ensures reliable pressure measurements, which

are critical for quantifying the pressure drop across lesions and evaluating the performance of vascular devices. With these low uncertainties, the sensors provide accurate and repeatable data that validate the fidelity of the arterial model.

The combined results from the flow rate and uncertainty analyses demonstrate the model's robustness as a testing platform. Accurate flow rate calculations confirm that the system realistically replicates physiological conditions, while low uncertainty values ensure that collected data is both precise and meaningful. These findings not only validate the arterial model but also guide critical design decisions, such as sensor placement and calibration, ensuring optimal functionality. Ultimately, these analyses support the development and optimization of vascular devices, improving their ability to treat peripheral artery disease effectively.

6.3.4 Differential Pressure – Internal Vessel Pressure Drop (Scott Alex)

An analysis of differential pressure within blood vessels will aid the team in further understanding the mechanics of blood flow within individuals with vascular diseases such as peripheral arterial diseases (PAD). The research of differential pressure within human vessels will be focused on the femoral artery vessel site. Differential pressure readings in the femoral artery are utilized to assess the presence and severity of PAD. This is achieved by identifying significant pressure drops between different sections of the leg, which may indicate stenosis or narrowing caused by calcification in the affected vessel.

In the femoral artery, blood flows downward, away from the heart, delivering oxygen-rich blood to the lower extremities. Under normal conditions, blood flows freely. However, if stenosis or calcification is present, it creates resistance to flow, resulting in a measurable pressure drop across the femoral artery. This pressure drop provides a key indicator of the severity of PAD in the vessel.

The term pressure gradient is commonly used to describe differential pressure. For the purposes of this analysis, it will be referred to as pressure drop, as this measurement is the focus of the study. Differential pressure is essential for generating blood flow and driving circulation throughout the body. In addition to the pressure gradient (or differential pressure), several other factors influence blood flow within the circulatory system, including vessel dimensions and geometry, vessel wall properties, and abnormalities such as calcified lesions caused by disease.

This analysis is designed to align with the team's broader objective, which involves modeling a calcified vessel. Specifically, it will account for the differential pressure consistent with the physiological conditions of an individual with PAD or a diseased vessel state.

Before conducting this analysis, several assumptions are considered. Differential pressure in this context is defined as the difference in pressure between two specific points without accounting for the distance between them. In contrast, the pressure gradient refers to the rate of pressure change over a given distance, describing how quickly pressure varies across a region. It is assumed that stenosis in the femoral artery impacts the differential pressure, although the exact extent of this impact is unknown for now in this analysis. Stenosis, caused by calcification, reduces the artery's patency (effective radius), increasing resistance to flow and resulting in a pressure drop, which is the primary focus of this analysis.

These assumptions are particularly relevant to PAD, as arterial narrowing is a common characteristic of the condition. The boundary conditions for this analysis are assumed to be the length of the femoral artery, with pressure measurements taken at the inlet (top) and outlet (bottom) of the artery. Blood is assumed to flow away from the heart, carrying oxygen-rich blood to the lower extremities, establishing the direction of flow. Additionally, it is assumed that blood flow is laminar prior to the stenosed region of the femoral artery, characterized by smooth, parallel layers of flow, with the highest velocity at the center of the vessel and minimal turbulence. These assumptions form the basis of the analysis and guide the modeling of blood flow in a stenosed or narrowing femoral artery.

Poiseuille's Law utilized for pressure drop (ΔP) [79].

$$\Delta P = \frac{8\mu LQ}{\pi r^4}$$

Where:

- ΔP = Pressure drop across the femoral artery, measured in pascal (Pa)
- μ = Dynamic viscosity, measured in pascal seconds ($Pa \cdot s$)
- L = Length of femoral artery location, measured in meters (m)
- Q = Volumetric flow rate, measured in meters cubed per seconds ($\frac{m^3}{s}$)
- r = Radius of the femoral artery, diseased state, measured in meters (m)

Properties of a PAD patient [75]:

- $\mu = 0.0035 Pa \cdot s$
- $L = 0.35 m$
- $Q = 2.53 \times 10^{-6} \frac{m^3}{s}$
- $r = 0.003 m$

Substituting the values and calculating the pressure drop of the PAD patient:

$$\Delta P = \frac{8(0.0035 Pa \cdot s)(0.35m) \left(2.53 \times 10^{-6} \frac{m^3}{s}\right)}{\pi(0.003m)^4}$$

$$\Delta P = 97.43 Pa$$

Properties of a healthy patient [75]:

- $\mu = 0.0035 Pa \cdot s$
- $L = 0.35 m$
- $Q = 2.53 \times 10^{-6} \frac{m^3}{s}$
- $r = 0.005 m$

Substituting the values and calculating the pressure drop of the healthy patient:

$$\Delta P = \frac{8(0.0035 Pa \cdot s)(0.35 m) \left(2.53 \times 10^{-6} \frac{m^3}{s}\right)}{\pi(0.005 m)^4}$$

$$\Delta P = 12.63 Pa$$

The results from this analysis prove that a significant pressure drop over the femoral artery location results in peripheral arterial disease within a patient. The analysis considered all assumptions and took into consideration a healthy patient's pressure drops over the same location as well. The difference was the parameters of the healthy state individual. The radius and volumetric flow were different due to area and shrinkage/expansion of radius in the patient. This was done to provide a comparison to the diseased-state individual. The narrowing of the artery shows to have impact on the pressure of the fluid and in return this results in the heart having to work harder. Often patients with PAD express concerns of

heart palpitations occurring at random or when exerting energy outside the normal day to day functions. This is due to the narrowing of the peripheral arteries, in this case the femoral artery. When the pressure drop is significant the human body responds with an increased heart rate to pump faster and must make up for the pressure lost.

The mathematical modeling of differential pressure in the femoral artery demonstrates the significant burden that PAD patients deal with due to the calcification lesion and narrowing of the artery. The results show an increase in the pressure gradient across the femoral artery. This model is employed for early detection of PAD to reduce the physiological stress on the cardiovascular system. Through calculations it provides a foundation for incorporating real-world clinical data into simulations to assess the impact of treatment options. Treatment options or interventions like stents, vessel bypass operations, and pharmacological interventions. The goal is to provide normal flow and normal pressure of the dynamic blood fluid to a patient with PAD.

6.4 Future Testing Potential

6.4.1 Calcified Lesion Dimensions

From the engineering requirements of the project QFD, the critical dimensions of the calcified lesion model include its length, thickness, and degree of vessel occlusion. The team's Anycubic Photon Mono 5S Pro should be able to manufacture calcified lesion models at their specified dimensions with tolerances under 0.1-mm [66]. The team can test that the dimensions of the manufactured part are accurate to the target values by measuring its length and thickness with a pair of calipers, and by visually inspecting its degree of vessel occlusion with a protractor.

6.4.2 Calcified Lesion Properties

From the engineering requirements of the QFD, the critical properties of the calcified lesion model include its durometer hardness and its adhesion strength to the vessel model. The team has selected a 90A TPU 3D printing filament with which to manufacture the calcified lesion model. This filament should have a durometer hardness of 90 on the Shore A scale or 39 on the Shore D scale [67]. The team can test that the durometer hardness of the calcified lesion model is accurate to the target value by performing the ASTM D2240 durometer hardness test on it. This test requires a Shore A digital durometer, which is used to make an indentation into the calcified lesion model, providing accurate durometer hardness values of its material in real-time [68].

The team has selected a high-viscosity cyanoacrylate adhesive with which to adhere the calcified lesion model to the vessel model. This adhesive should have an overlap shear strength (adhesive strength parallel to the bond) of approximately 2,000 psi or 13,970 kPa [59]. The team can test that the adhesive strength of this adhesive is accurate to the target value by performing the ASTM D1002 overlap shear strength test on it. This test requires a universal testing machine & software, a load cell, and side-action grips, which measure the force required to break an adhesive bond of a specified size between two metal plates [69]. This testing procedure is relatively inaccessible and expensive, so performing it may be unrealistic with the team's allotted time and budget. Thus, the team may need to rely on the adhesive's technical data sheet to determine its adhesive strength.

6.4.3 Blood Analog Properties

As the QFD outlines, the critical properties of the blood analog are the density, viscosity, flow rate, and pressure within the system. The density and viscosity have been calculated and tested in section 6.3.1 of this report. To test the design for pressure and flow rate, the team will implement a hall effect flow rate sensor and at least two pressure transducers within the model. These sensors will read out data from the system to an LCD display for the user to see. These integrated sensors will allow the team to run

the system and check if the critical properties are within an acceptable range. The team can then make changes to the pump system to achieve a flow rate and pressure within the acceptable range.

6.4.4 Calcified Vessel Dimensions

According to the engineering requirements outlined in the project's QFD, the vessel dimensions are designed to align with those of the calcified lesion model. The critical dimensions include the vessel's length, thickness, and diameter. These dimensions are carefully defined during the CAD development process to ensure the additive manufacturing process produces models with high dimensional accuracy that adhere to the specified engineering requirements. After manufacturing with the team's Anycubic Photon Mono 5S Pro 3D printer, the vessel dimensions can be tested and verified by measuring the produced model using precision tools. This ensures the dimensions meet the targeted values and remain within the specified tolerance limits.

6.4.5 Calcified Vessel Properties

Per the engineering requirements outlined in the team's QFD, the critical vessel model properties are the pressure capacity and opacity. The vessel properties are designed to consider the adhesion of the calcified lesion model and the vessel model itself. Considering the 50% opacity target, the team selects a 40D TPU 3D printing filament that is transparent in color. The transparent property of the filament attempts to meet the 50% opacity target. The 40D TPU filament has a Shore hardness of 40D, meaning it is relatively soft and flexible, which makes it ideal for the team's vessel model. The selected 3D printing filament has a tensile yield strength of 0.8 MPa. The pressure of an individual with PAD is relatively 200 mmHg, which converts to 26.7 kPa. The team's 3D printing filament proves to meet the pressure targets of the engineering requirements through calculations. The team can test the vessel model properties by applying a pressure of 26.7 kPa to the vessel model by performing a simulation with a fluid pump set to the pressure value and allowing water to flow through the printed model. The team can visually inspect the model while in simulation for any leaks or defects involving pressure loss due to vessel properties.

The team can test opacity requirements by either visual inspection or following ASTM D1003, the standard test method in measuring luminous transmittance of transparent plastics [80]. The method for visual inspection involves subjective assessment by an observer. The vessel is viewed against a standardized test object with high contrast to evaluate its transparency. The method for ASTM D1003 transmittance measurement involves measuring the amount of light that passes through the 3D printed vessel model material. The model is placed between a light source and a detector. The detector measures the intensity of light before and after passing through the material. The instrument used for transmittance measurement is a transmittance meter or a spectrophotometer. Despite the associated costs to the team's budget, there are cost-effective alternatives available for this test. One such option is to utilize a handheld light transmission meter, such as the Qualtech QPI-115A or Linshang LS116. A final alternative to achieve this opacity requirement would be to get the team's clients involved and present them with the team's product for their visual inspection and interpretation.

7 CONCLUSIONS

The W.L. Gore & Associates Calcified Vessel Model capstone project aims to develop a realistic simulation of a calcified vessel experiencing peripheral arterial disease (PAD) for the purpose of medical device testing and research. The primary project goal is to replicate the properties of a human femoral artery with varying levels of calcified lesion buildup, as these are the simulated use conditions for which the client desires to test and evaluate their medical devices. The team's client, W. L. Gore & Associates – Medical, will be evaluating their vascular interventional device, the Viabahn endoprosthesis, with this calcified vessel model. Critical requirements for a successful completion of this project include accurately simulating vessel dimensions and anatomy of the femoral artery, replicating the compliance of vessel walls, mimicking the hardness and adhesion of calcifications to vessel walls, and producing realistic blood flow dynamics. The calcified vessel model will also need to accommodate pressure and/or flow rate sensor integration for precise measurements of model behavior and relevant data collection. The model should also be compatible with other common medical devices intended to treat PAD.

Throughout this half of the semester, the team took a fundamental approach to the concept generation, concept evaluation, and development of the calcified vessel model. Essential engineering requirements were converted into measurable selection criteria, including the following: vessel dimensions, material properties, flow characteristics, and metrology capabilities. Mathematical models were conducted to ensure that the final design meets physiological conditions for vessel compliance, blood analog flow rates, lesion adhesion, lesion material, vessel material, vessel pressure, and vessel stress forces. Material selection for model components was based on accurately replicating the physiological behaviors of human vessel properties, such as elasticity of the vessel walls and hardness of the calcified lesion.

The final design concept selected consists of a right-side femoral artery model structure with branching vessels that end in short lengths, with a calcification site of varying hardness distributed along the main artery. The model will be equipped with a blood analog fluid system capable of steady flow and pulsatile flow. This system ensures realistic circulation simulation of the vessel model, and circulation through the calcified lesion area. Material selections for the vessel and calcification are within an allowable range of human blood vessel properties. The team aims to produce varying types of calcification lesion models to cover a range of diseased states. These varying levels of calcification will enhance the model and provide a greater range span for medical research on these medical devices. The metrology integration utilizes sensors and flow meters for collecting and displaying relevant data of the system, providing useful information for the operator(s) of the model.

The final selected design concept tentatively meets all project customer and engineering requirements at this stage of the design process. If this design concept for a calcified vessel model is successful, it will serve as a platform for testing and evaluating the performance and deployment of peripheral arterial interventional devices, contributing to their continued development and efficacy in real surgical procedures for the treatment of PAD. The team has developed basic prototypes to demonstrate the ability for the design concept to meet some of the engineering requirements. Moving forward in this project, the team will focus on refining the vessel and calcification models' anatomies, adding features within the metrology system to collect additional data, and enhancing simulation accuracy through prototype iterations and modifications.

8 REFERENCES

- [1] “PolyFlex™ TPU90,” *Polymaker*. <https://polymaker.com/product/polyflex-tpu90/>
- [2] H. P. G. Fon +495201849551 Apotheckerstrasse 1, D.-33790 Halle Westfalen, office@holst-porzellan.de, “Holst Porzellan/Germany - Porcelain retail store,” *Holst Porzellan/Germany - Porcelain retail store*. <https://holst-porzellan.com/b2c/en/knowledge/characteristics/hardness/>
- [3] AZoM, “Stainless Steels - Stainless 304 Properties, Fabrication and Applications,” *AZoM.com*, Jun. 27, 2019. <https://www.azom.com/article.aspx?ArticleID=2867>
- [4] F. M. White and H. Xue, *Fluid mechanics*. New York, Ny McGraw-Hill, 2021.
- [5] P. Lewis, J. V. Psaila, W. T. Davies, K. McCarty, and J. P. Woodcock, “Measurement of volume flow in the human common femoral artery using a duplex ultrasound system,” *Ultrasound in Medicine & Biology*, vol. 12, no. 10, pp. 777–784, Oct. 1986, doi: [https://doi.org/10.1016/0301-5629\(86\)90075-x](https://doi.org/10.1016/0301-5629(86)90075-x).
- [6] D. J. Vitello, R. M. Ripper, M. R. Fettiplace, G. L. Weinberg, and J. M. Vitello, “Blood Density Is Nearly Equal to Water Density: A Validation Study of the Gravimetric Method of Measuring Intraoperative Blood Loss,” *Journal of Veterinary Medicine*, vol. 2015, pp. 1–4, 2015, doi: <https://doi.org/10.1155/2015/152730>.
- [7] “Coronary Artery Calcification and its Progression: What Does it Really Mean?,” *JACC: Cardiovascular Imaging*, vol. 11, no. 1, pp. 127–142, Jan. 2018, doi: <https://doi.org/10.1016/j.jcmg.2017.10.012>.
- [8] F. Gijssen *et al.*, “Expert recommendations on the assessment of wall shear stress in human coronary arteries: existing methodologies, technical considerations, and clinical applications,” *European Heart Journal*, vol. 40, no. 41, pp. 3421–3433, Sep. 2019, doi: <https://doi.org/10.1093/eurheartj/ehz551>.
- [9] K. Chun, H. Choi, and J. Lee, “Comparison of mechanical property and role between enamel and dentin in the human teeth,” *Journal of Dental Biomechanics*, vol. 5, no. 0, Feb. 2014, doi: <https://doi.org/10.1177/1758736014520809>.
- [10] “Ender-3 V3 KE,” *creality*. <https://www.creality.com/products/creality-ender-3-v3-ke>
- [11] “Precision CNC Machining,” *Metal Cutting Corporation*. <https://metalcutting.com/knowledge-center/precision-cnc-machining/>
- [12] Y. Dong *et al.*, “Lower limb arterial calcification and its clinical relevance with peripheral arterial disease,” *Frontiers in Cardiovascular Medicine*, vol. 10, Nov. 2023, doi: <https://doi.org/10.3389/fcvm.2023.1271100>.
- [13] W. D. Callister and D. G. Rethwisch, *Materials Science and Engineering: an Introduction*, 10th ed. Hoboken, Nj Wiley, 2020.
- [14] M. R. Spiegel, J. J. Schiller, and R. Alu Srinivasan, *Probability and statistics*. New York: McGraw-Hill, 2013.
- [15] “GORE® VIABAHN® Endoprosthesis,” Gore Medical. <https://www.goremedical.com/products/viabahn>
- [16] A. Fujino *et al.*, “A New Optical Coherence Tomography-Based Calcium Scoring System to Predict Stent Underexpansion,” *Eurointervention*, vol. 13, no. 18, pp. 2182–2189, Apr. 2018, doi: <https://doi.org/10.4244/eij-d-17-00962>.
- [17] M. Tsutsumi *et al.*, “Carotid Artery Stenting for Calcified Lesions,” *American Journal of Neuroradiology*, vol. 29, no. 8, pp. 1590–1593, May 2008, doi: <https://doi.org/10.3174/ajnr.a1126>.
- [18] D. Tang *et al.*, “Quantifying Effects of Plaque Structure and Material Properties on Stress Distributions in Human Atherosclerotic Plaques Using 3D FSI Models,” *Journal of Biomechanical Engineering*, vol. 127, no. 7, pp. 1185–1194, Jul. 2005, doi: <https://doi.org/10.1115/1.2073668>.
- [19] T. C. Hodges *et al.*, “Ultrasound Determination of Total Arterial Wall Thickness,” *Journal of Vascular Surgery*, vol. 19, no. 4, pp. 745–753, Apr. 1994, doi: [https://doi.org/10.1016/S0741-5214\(94\)70051-6](https://doi.org/10.1016/S0741-5214(94)70051-6).

- [20] International Organization for Standardization, Cardiovascular implants — Endovascular devices (ISO 25539-2:2020). 2020.
- [21] Average Cost (Per Unit Cost). (2024, September 17). Wall Street Prep. <https://www.wallstreetprep.com/knowledge/average-cost/>
- [22] Casilang, M. (n.d.). Comparing Traditional and Contemporary Manufacturing Methods. Jameco Electronics. <https://www.jameco.com/Jameco/workshop/ProductNews/casting-3d-printing-compare-contrast.html>
- [23] Chung, P., Heller, J. A., Etemadi, M., Ottoson, P. E., Liu, J. A., Rand, L., & Roy, S. (2014). Rapid and Low-cost Prototyping of Medical Devices Using 3D Printed Molds for Liquid Injection Molding. *Journal of Visualized Experiments*, 88. <https://doi.org/10.3791/51745>
- [24] Figliola, R. S., & Beasley, D. E. (2019a). Theory and design for mechanical measurements (pp. 1–33). Wiley.
- [25] Figliola, R. S., & Beasley, D. E. (2019b). Theory and design for mechanical measurements (pp. 315–354). Wiley.
- [26] Guttridge, C., Shannon, A., O’Sullivan, A., O’Sullivan, K. J., & O’Sullivan, L. W. (2022). Biocompatible 3D printing resins for medical applications: A review of marketed intended use, biocompatibility certification, and post-processing guidance. *Annals of 3D Printed Medicine*, 5, 100044. <https://doi.org/10.1016/j.stlm.2021.100044>
- [27] Herrmann, J., Babic, M., Tölle, M., Markus, & Schuchardt, M. (2020). Research Models for Studying Vascular Calcification. *International Journal of Molecular Sciences*, 21(6), 2204–2204. <https://doi.org/10.3390/ijms21062204>
- [28] Hossler, F. E. (2003). Vascular Corrosion Casting. *Microscopy Today*, 11(4), 46–47. <https://doi.org/10.1017/s1551929500053098>
- [29] How Cost-Effective is SLA 3D Printing Compared to Other Manufacturing Methods? - ZONGHENG3D. (n.d.). <https://www.zongheng3d.com/>. <https://www.zongheng3d.com/how-cost-effective-is-sla-3d-printing-compared-to-other-manufacturing-methods/>
- [30] International, A. (2016, December 27). compass. [Compass.astm.org](https://compass.astm.org/). <https://compass.astm.org/document/?contentCode=ASTM%7CF0748-16%7Cen-US&proxycl=https%3A%2F%2Fsecure.astm.org&fromLogin=true>
- [31] Mamo, H. B., Adamiak, M., & Kunwar, A. (2023). 3D printed biomedical devices and their applications: A review on state-of-the-art technologies, existing challenges, and future perspectives. *Journal of the Mechanical Behavior of Biomedical Materials*, 143, 105930. <https://doi.org/10.1016/j.jmbbm.2023.105930>
- [32] “Heart Surgery Surgeon Simulator Manufacturer, Heart Disease Prediction Model | Preclinic Medtech,” Preclinic Medtech (Shanghai) Co., Ltd. , 2024. <https://www.preclinicsim.com/products/silicone-cardiac-vessels/> (accessed Sep. 18, 2024).
- [33] “Endovascular Simulator,” ViVitro Labs. <https://vivitrolabs.com/product/endovascular-ev-simulator/>
- [34] Anatomy, Blood Vessels C. J. Arthurs et al., “CRIMSON: An open-source software framework for cardiovascular integrated modelling and simulation,” *PLOS Computational Biology*, vol. 17, no.5, p. e1008881, May 2021, doi: <https://doi.org/10.1371/journal.pcbi.1008881>.
- [35] W. D. Tucker, “Anatomy, Blood Vessels,” Nih.gov, Aug. 08, 2023. <https://www.ncbi.nlm.nih.gov/books/NBK470401/>
- [36] S. Yu and C. M. McEniery, “Central Versus Peripheral Artery Stiffening and Cardiovascular Risk,” *Arteriosclerosis, Thrombosis, and Vascular Biology*, vol. 40, no. 5, pp.1028–1033, May 2020, doi: <https://doi.org/10.1161/atvbaha.120.313128>.
- [37] T. C. Hodges *et al.*, “Ultrasound determination of total arterial wall thickness,” *Journal of Vascular Surgery*, vol. 19, no. 4, pp. 745–753, Apr. 1994, doi: [https://doi.org/10.1016/S0741-5214\(94\)70051-6](https://doi.org/10.1016/S0741-5214(94)70051-6).

- [38] Y. Dong et al., “Lower limb arterial calcification and its clinical relevance with peripheral arterial disease,” *Frontiers in Cardiovascular Medicine*, vol. 10, Nov. 2023, doi: <https://doi.org/10.3389/fcvm.2023.1271100>.
- [39] “Coronary artery calcification: Causes, treatment, and outlook,” Healthline, <https://www.healthline.com/health/coronary-artery-disease/calcified-coronary-artery-disease> (accessed Oct. 19, 2024).
- [40] M. Zhou et al., “Wall shear stress and its role in atherosclerosis,” *Frontiers in cardiovascular medicine*, <https://www.ncbi.nlm.nih.gov/pmc/articles/PMC10106633/> (accessed Oct. 19, 2024).
- [41] “Vascular wall shear stress: Basic principles and methods,” https://www.hellenicjcardiol.org/archive/full_text/2005/1/2005_1_9.pdf (accessed Oct. 19, 2024).
- [42] J. E. Hall and M. E. Hall, *Guyton and Hall textbook of medical physiology*, 14th ed. Philadelphia, Pa: Elsevier, 2021.
- [43] J. Tortora and B. H. Derrickson, *Tortora’s Principles of Anatomy & Physiology Textbook*, 15th ed. Wiley, 2017.
- [44] “Heart Surgery Surgeon Simulator Manufacturer, Heart Disease Prediction Model | Preclinic Medtech,” Preclinic Medtech (Shanghai) Co., Ltd. , 2024. <https://www.preclinic-sim.com/products/silicone-cardiac-vessels/> (accessed Sep. 18, 2024).
- [45] “Endovascular Simulator,” ViVitro Labs. <https://vivitrolabs.com/product/endovascular-ev-simulator/>
- [46] “3D Biology,” 3D Biology - Creative Biolabs, <https://www.creative-biolabs.com/3d-biology/> (accessed Oct. 20, 2024).
- [47] Gore, *Instructions for use for: Gore Viabahn Endoprosthesis*, 1st ed., vol. 1. W.L. Gore & Associates, 2016. Accessed: Sep. 18, 2024. [Online]. Available: <https://eifu-render.goremedical.com/PDFPrint.aspx?DocId=33>
- [48] M. Creager and J. Loscalzo, *Harrison’s Principles of Internal Medicine*, 21st ed. McGraw-Hill Education, 2022, p. Arterial diseases of the extremities. Accessed: Sep. 18, 2024. [Online]. Available: <https://accessmedicine-mhmedical-com.libproxy.nau.edu/content.aspx?sectionid=265454926&bookid=3095#266382434>
- [49] Qi, Y., Wang, J., Zhao, J. *et al.* Comparison of BARD®LIFESTREAM™ covered balloon-expandable stent versus GORE® VIABAHN™ covered self-expandable stent in treatment of aortoiliac obstructive disease: study protocol for a prospective randomized controlled trial (NEONATAL trial). *Trials* **23**, 392 (2022). <https://doi.org/10.1186/s13063-022-06332-7>
- [50] S.-E. Stent, “Self-Expanding Stent Grafts - Endovascular Today,” *Endovascular Today*, 2024. <https://evtoday.com/device-guide/us/self-expanding-stent-grafts> (accessed Sep. 18, 2024)
- [51] F. Nematzadeh, “A computational study of effects of material properties, strain level, and friction coefficient on smart stent behavior and peripheral artery performance during the interaction process,” *Journal of intelligent material systems and structures*, vol. 33, no. 5, pp. 703–714, 2022, Accessed: Sep. 18, 2024. [Online]. Available: <https://illiad.nau.edu/illiad/illiad.dll?Action=10&Form=75&Value=780137>
- [52] W. L. GORE & ASSOCIATES, “W. L. GORE & ASSOCIATES ENHANCES GORE® VIABAHN® ENDOPROSTHESIS PORTFOLIO WITH LOWER PROFILE DELIVERY,” W. L. GORE & ASSOCIATES, Sep. 2021. Accessed: Sep. 18, 2024. [Online]. Available: <https://www.goremedical.com/resource/21104751-en>
- [53] United States Department of Labor, “Regulations (Standards - 29 CFR) | Occupational Safety and Health Administration,” *Osha.gov*, 2019. <https://www.osha.gov/laws-regs/regulations/standardnumber/1910>
- [54] Genie Prep, “Pump Power Formula (FE Exam Review),” *YouTube*, Sep. 06, 2019. <https://www.youtube.com/watch?v=RCZh8119x0g> (accessed Sep. 18, 2024).
- [55] Ultimaker, *How to design for FFF 3D printing*. 2019. Available: <https://ultimaker.com/wp-content/uploads/2024/06/How-to-design-for-FFF-1.pdf>

- [56] 3M, *Product Selection Guide*. 2024. Available: <https://multimedia.3m.com/mws/media/3282800/product-selection-guide.pdf>
- [57] 3M, “The Science of Adhesion: Bonding & Assembly Education | 3M,” *3m.com*, 2021. https://www.3m.com/3M/en_US/bonding-and-assembly-us/resources/science-of-adhesion/
- [58] Gorilla Glue, “Gorilla Super Glue - Incredibly Strong Glue | Gorilla Glue,” Gorilla Glue UK. <https://uk.gorillaglu.com/gorilla-super-glue/>
- [59] “3M™ Scotch-Weld™ Plastic & Rubber Instant Adhesive PR1500 | 3M United States,” *3m.com*, 2024. https://www.3m.com/3M/en_US/p/d/b40066920/
- [60] FormLabs, “Elastic 50A Resin V2,” *Formlabs*. <https://formlabs.com/store/materials/elastic-50a-resin-v2/>
- [61] FormLabs, “Flexible 80A Resin,” *Formlabs*. <https://formlabs.com/store/materials/flexible-80a-resin/>
- [62] A. P. Ebrahimi, “Mechanical Properties of Normal and Diseased Cerebrovascular System,” *Journal of Vascular and Interventional Neurology*, vol. 2, no. 2, p. 155, Apr. 2009, Available: <https://pubmed.ncbi.nlm.nih.gov/articles/PMC3317338/>
- [63] FormLabs, “Validating Isotropy in SLA 3D Printing,” *Formlabs*. <https://formlabs.com/blog/isotropy-in-sla-3d-printing/>
- [64] National Heart, Lung, and Blood Institute, “High Blood Pressure - What Is High Blood Pressure (Hypertension) | NHLBI, NIH,” *www.nhlbi.nih.gov*, Apr. 25, 2024. <https://www.nhlbi.nih.gov/health/high-blood-pressure>
- [65] G. Secco *et al.*, “Very high-pressure dilatation for undilatable coronary lesions: indications and results with a new dedicated balloon,” *EuroIntervention*, vol. 12, no. 3, pp. 359–365, Jun. 2016, doi: https://doi.org/10.4244/eijy15m06_04.
- [66] Anycubic, “Anycubic Photon Mono M5s Pro,” *ANYCUBIC-US*, 2024. <https://store.anycubic.com/products/photon-mono-m5s-pro>
- [67] Polymaker US, “PolyFlex™ TPU90,” *Polymaker US*, 2021. <https://us.polymaker.com/products/polyflex-tpu90>
- [68] ASTM International, *Standard Test Method for Rubber Property—Durometer Hardness*. 2021.
- [69] ASTM International, *Standard Test Method for Apparent Shear Strength of Single-Lap-Joint Adhesively Bonded Metal Specimens by Tension Loading (Metal-to-Metal)*. 2019.
- [70] “Y14.5 dimensioning and Tolerancing,” ASME, <https://www.asme.org/codes-standards/find-codes-standards/y14-5-dimensioning-tolerancing>
- [71] “ASME Y14.46 product definition for additive manufacturing,” ASME, [https://www.asme.org/codes-standards/find-codes-standards/y14-46-product-definition-additive-manufacturing-\(1\)/2022/pdf](https://www.asme.org/codes-standards/find-codes-standards/y14-46-product-definition-additive-manufacturing-(1)/2022/pdf)
- [72] T. S. Team, “IPC J-STD-001 Standard for Soldering,” *Sierra Circuits*, Sep. 23, 2021. <https://www.protoexpress.com/blog/ipc-j-std-001-standard-soldering-requirements/>
- [73] E. Nader *et al.*, “Blood Rheology: Key Parameters, Impact on Blood Flow, Role in Sickle Cell Disease and Effects of Exercise,” *Frontiers in Physiology*, vol. 10, no. 10, Oct. 2019, doi: <https://doi.org/10.3389/fphys.2019.01329>.
- [74] “Human Blood - an overview | ScienceDirect Topics,” [www.sciencedirect.com](https://www.sciencedirect.com/topics/engineering/human-blood). <https://www.sciencedirect.com/topics/engineering/human-blood>
- [75] Author links open overlay panel D.B. Camasão and A. the last 50 years, “The mechanical characterization of blood vessels and their substitutes in the continuous quest for physiological-relevant performances. A critical review,” *Materials Today Bio*, <https://www.sciencedirect.com/science/article/pii/S2590006421000144#:~:text=The%20elastic%20modulus%20is%20calculated%20by%20the>

- [76] ISO/IEC, "Medical device software – Software life cycle processes," ISO/IEC 62304:2006, International Organization for Standardization, Geneva, Switzerland, 2006. [Online]. Available: <https://www.iso.org/obp/ui/en/#iso:std:iec:62304:ed-1:v1:en>
- [77] ASTM International, "Standard Specification for Pressure Decay Leak Test Method," ASTM F2070-00(2017), ASTM International, West Conshohocken, PA, 2017. [Online]. Available: <https://www.astm.org/f2070-00r17.html>
- [78] ISO, "Water meters for cold potable water and hot water – Part 2: Test methods," ISO 4064-2:2014, International Organization for Standardization, Geneva, Switzerland, 2014. [Online]. Available: <https://www.iso.org/obp/ui/en/#iso:std:iso:4064:-2:ed-4:v1:en>
- [79] Libretexts, "12.4: Viscosity and laminar flow; Poiseuille's law," Physics LibreTexts, [https://phys.libretexts.org/Bookshelves/College_Physics/College_Physics_1e_\(OpenStax\)/12%3A_A_Fluid_Dynamics_and_Its_Biological_and_Medical_Applications/12.04%3A_Viscosity_and_Laminar_Flow_Poiseuilles_Law](https://phys.libretexts.org/Bookshelves/College_Physics/College_Physics_1e_(OpenStax)/12%3A_A_Fluid_Dynamics_and_Its_Biological_and_Medical_Applications/12.04%3A_Viscosity_and_Laminar_Flow_Poiseuilles_Law)
- [80] "Professional light transmission meter - ASTM D1003 ASTM D1494 ASTM D1746 ISO 9050," QUALTECH PRODUCTS INDUSTRY, <https://www.qualtechproductsindustry.com/products/appearance-testing-instruments/reflection-opacity-testing-instruments/light-transmission-meter/?form=MG0AV3>