

# **Stirling Refrigerator**

## **Mid-Point Report**

**Luis Gardetto**

**Ahmad Althomali**

**Abdulrahman Alazemi**

**Faiez Alazmi**

**John Wiley**



**2017-2018**

**Project Sponsor: Dr. David Trevas**

**Faculty Advisor: Mr. David Willy**

**Instructor: Dr. Sarah Oman**

## **DISCLAIMER**

This report was prepared by students as part of a university course requirement. While considerable effort has been put into the project, it is not the work of licensed engineers and has not undergone the extensive verification that is common in the profession. The information, data, conclusions, and content of this report should not be relied on or utilized without thorough, independent testing and verification. University faculty members may have been associated with this project as advisors, sponsors, or course instructors, but as such they are not responsible for the accuracy of results or conclusions.

## **Executive Summary**

Refrigeration is a ubiquitous application of engineering concepts, with implications like food preservation techniques, superconducting-magnet involving techniques and crystal harvesting techniques. The refrigeration process involves the removal of excess heat from specified objects, thereby enhancing the cooling or the chilling effect. Refrigerators come in many sizes and shapes, according to the available expertise, materials, and applications. With the advancement of technology and the emergence of various contemporary issues such as cost, size, and dangerous chemicals among others, researchers are embarking on studies, which can facilitate the design and development of a more efficient refrigerator, capable of performing the desired work as presupposed with minimal problems. The current proposal focuses on Stirling cryocoolers, which have been recognized as one of the most efficient coolers of the current era. The key advantages of these chillers include low power consumption rates as well as the use of non-hazardous refrigerants.

In this project, a refrigerator based on existing Free Piston Stirling technology is thus proposed and considered. The design of the cooler considers the requirements of the client, Dr. Trevas, who requested a device that can fit on a bench and is capable of chilling six-packs of sodas from room temperature. Furthermore, the client requested that the device be developed for the ME 495 Lab, as part of the course requirement.

Additional specifications will include durable materials that can support the motor, piston, and displacer as well as a mounting framework and digital display. The design will require the use of a lathe to shape the circular profiles in many of the parts for instance the piston, displacer, and cylinder, while bending operations on sheet metal will probably be employed to create the heat sink on the hot region on the cylinder. A tap will additionally be used to create threads with seal

accommodations for corresponding temperature and pressure sensor ports. Material selection for the regenerator matrix and surrounding insulation will be drawn from a variety of metals, such as stainless steel, that have suitable heat capacity and conductivity characteristics.

# TABLE OF CONTENTS

## Contents

|                                                     |    |
|-----------------------------------------------------|----|
| DISCLAIMER .....                                    | 1  |
| TABLE OF CONTENTS .....                             | 3  |
| 1 BACKGROUND .....                                  | 1  |
| 1.1 Introduction .....                              | 1  |
| 1.2 Project Description .....                       | 1  |
| 2 REQUIREMENTS .....                                | 2  |
| 2.1 Customer Requirements (CRs).....                | 2  |
| 2.2 Engineering Requirements (ERs).....             | 3  |
| 2.3 Testing Procedures (TP's) .....                 | 4  |
| 2.4 House of Quality (HoQ) .....                    | 7  |
| 3 EXISTING DESIGNS .....                            | 9  |
| 3.1 Design Research .....                           | 9  |
| 3.2 System Level .....                              | 9  |
| 3.2.1 Existing Design #1: Alpha .....               | 9  |
| 3.2.2 Existing Design #2: Beta.....                 | 12 |
| 3.2.3 Existing Design #3: Gamma .....               | 13 |
| 3.2.4 Existing Design #4: Free Piston.....          | 14 |
| 3.3 Functional Decomposition.....                   | 15 |
| 3.3.1 Black Box Model .....                         | 15 |
| 3.3.2 Functional Model .....                        | 16 |
| 3.4 Subsystem Level.....                            | 17 |
| 3.4.1 Subsystem #1: Displacer.....                  | 17 |
| 3.4.2 Subsystem #2: Piston .....                    | 18 |
| 3.4.3 Subsystem #3: Flywheel .....                  | 18 |
| 3.4.4 Subsystem #4: Gaskets & Seals .....           | 18 |
| 3.4.5 Subsystem #5: Fin Types .....                 | 21 |
| 3.4.6 Subsystem #5: Linear/Rotary Motor.....        | 22 |
| 3.4.7 Subsystem #6: Regenerator Material .....      | 23 |
| 4 DESIGNS CONSIDERED .....                          | 27 |
| 4.1 Design #1: Benchtop Apparatus .....             | 27 |
| 4.2 Design #2: Solar powered Ice-Chest .....        | 27 |
| 4.3 Design #3: Dual Piston Cryocooler .....         | 28 |
| 4.4 Design #4: Inline regenerative cryocooler.....  | 29 |
| 5 DESIGN SELECTED –.....                            | 30 |
| 5.1 Rationale for Design Selection.....             | 30 |
| 5.2 Design Description .....                        | 31 |
| 6 Proposed Design .....                             | 34 |
| Appendix A .....                                    | 40 |
| Design #5: Hut form cryocooler .....                | 40 |
| Design #6: Alpha-shaped cryocooler .....            | 41 |
| 6.1 Design #8: Active cryocooler .....              | 41 |
| 6.2 Design #9: Double Regenerated Cooler .....      | 42 |
| 6.3 Design #10: Water Cooled Compressor Cooler..... | 42 |
| Appendix B:.....                                    | 1  |

# **1 BACKGROUND**

## ***1.1 Introduction***

Experimental test equipment plays a crucial role in the curriculum of ME 495 Experimental Methods Lab. Design of a Stirling Cooling apparatus that would serve as a demonstration model has been requested by our client, Dr. David Trevas. As one of the contributing Professors to the senior level ME495 Laboratory, Dr. Trevas is interested in the creation of an experiment that requires future students to investigate the thermodynamic cycle that is utilized by Stirling technology. Importance has been placed in a benchtop scale Stirling cooler model that has variable inputs of energy sources, working gas types, temperature output.

Stakeholders would include future mechanical engineering students, the mechanical engineering faculty of Northern Arizona University (NAU), and similar laboratory-based courses in thermodynamics and fluid-dynamics at other universities. Design of experiments, as required by the course, includes a general property or process related to the measurement of fluids and temperature. Techniques involving the collection of data, methods of quantifying data, and replication of industrial applications as they relate to the Stirling cycle can be incorporated in this project. Benefits

Contemporary issues that inspire investigations into alternative methods of refrigeration that safely and effectively achieve customer requirements is the primary intention of this project. Stirling cryocoolers are widely used in many industries and offer efficient cooling solutions without potentially hazardous refrigerants or large electrical consumption. The following sections describe the project, list customer and engineering requirements, mention existing designs, suggest possible new designs, and finally lists design selection for construction.

## ***1.2 Project Description***

Discussions with the client that describe the project intentions, purpose, scope, and importance had been conducted in person as well as consultations with our experienced mentor, Professor David Willie. In the initial interview with our client, Dr. Trevas stated:

“I want something that can fit on a bench that actually cools down a six-pack of sodas from room temperature to a refreshing chill. It should be designed to be used in the ME 495 Lab as one of the experiments required for the course.”

Details and reference sources were discussed with our client during the rest of the interview along with personal experience testing and experimenting with Stirling technology. Possible configurations were suggested by our client that include the use of the free piston type due to experience with that system.

The model must be constructed from durable material that provides stable structural support for the motor/piston/displacer assembly along with a mounting surface for digital display monitors. An insulated cooling vessel will house the test medium along with imbedded thermocouples that monitor interior temperature.

## 2 REQUIREMENTS

The client has requested the design and construction of a Stirling engine or cooler that can be used to demonstrate the thermodynamic characteristics of the Stirling cycle. This device will be designed to conduct experiments that relate to subjects taught in the Experimental Methods lab (ME 495) offered at NAU Mechanical Engineering department. The following sections describe customer and engineering requirements that have been determined from background research and interviews with our client, Dr. David Trevas, and this teams' academic mentor, Professor David Willy.

### 2.1 Customer Requirements (CRs)

For the customer requirements (CRs), we came up with customer needs that will be prioritized in the design and construction of a Stirling refrigerator. Client communication was conducted through several interviews to determine weights of suggested requirements. Table 1 shows breakout requirements and weights as listed on house of quality (figure 1). The customer weights were rated from a scale of 1-5, where five is the most important and one is the least important.

*Table 1 Customer Requirements*

| <b>Customer Requirement</b>   | <b>Weight</b> |
|-------------------------------|---------------|
| Heat transfer from cooler     | 5             |
| Fits in educational lab space | 4             |
| Externally powered            | 3             |
| Educational                   | 3             |
| Safe                          | 5             |
| Lowest Cost Possible          | 5             |
| Durable                       | 3             |
| Manufacturable                | 4             |

The overall project objective is to have a Stirling/Cryocooler engine designed safe for students to learn more about thermodynamic cycles and how they function in real life. Another objective is to create an affordable and durable design to please our client and to allow multiple generations of engineering students to be exposed to our physical model. In the House of Quality (Section 2.3) the customer need weights and how they are related to the engineering requirements (ERs) are provided.

## 2.2 Engineering Requirements (ERs)

The engineering requirements were determined by deriving measurable characteristics from the customer requirements. The table below shows the engineering requirements along with their targets. For more detailed information (units) regarding the engineering requirements, refer to the technical analyses (Chapter 6).

*Table 2 Targets for ER's*

| <b>Engineering Requirement</b>    | <b>Target Value</b>                           |
|-----------------------------------|-----------------------------------------------|
| Vessel Pressure                   | > 1 MPa                                       |
| Power Input                       | ~2 kW                                         |
| Regenerator Porosity              | > 40; < 70                                    |
| Regenerator Specific Heat         | > $0.4 \frac{\text{J}}{\text{g} * \text{K}}$  |
| Regenerator Packing Factor        | > 40                                          |
| Insulation Material Specific Heat | > $.3 \frac{\text{kJ}}{\text{kg} * \text{K}}$ |
| Regenerator Material Conductivity | > $14 \frac{\text{W}}{\text{m} * \text{K}}$   |
| Number of Seals                   | < 4                                           |
| Frequency                         | > 30 Hz; < 100 Hz                             |
| System Volume                     | < $.1 \text{ m}^3$                            |

The targets for the ER's been explained. Namely, the power input was based on the average power supplied by a wall outlet; the regenerator porosity, and specific heat were based off values found in the literature for various materials, while specific attention was given to stainless steel properties because of its presence as a common regenerator material. The conductivity of the insulation was based on values found in the literature for different alloy insulators. The number of seals was determined based on the different configurations for a Stirling refrigerator as well as the team's plans to implement sensors within the refrigeration system. The frequency was based on the various values found in the literature as well as information supplied by companies who commercially produced Stirling coolers and engines. Estimating the overall volume based on context given by Dr. Trevas, namely, it will fit in a lab space. The dead volume fraction was also estimated based off various values found in the literature, while keeping in mind that this was an important parameter, with respect to power input.

### 2.3 Testing Procedures (TP's)

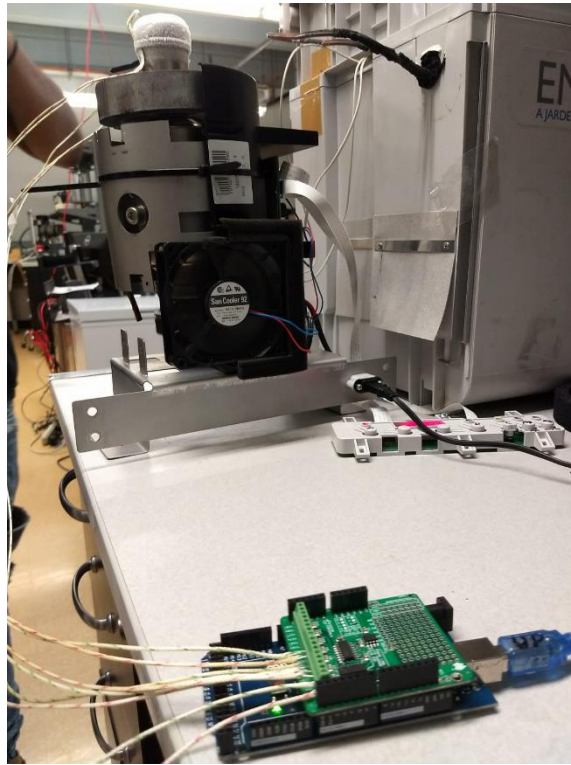
The proposed concept shown in figure 18 resembles the Envirocooler in its simplest form. Disassembly of the Envirocooler revealed a Twinbird Corporation Stirling cryocooler (Figure 1) that was connected to a thermo-siphon system heat pipe assembly that transferred the cooling action throughout the insulated cooling chamber. Initial analysis was conducted using the Twinbird cryocooler after it was removed from the cooler assembly.



**Figure 1.** Twinbird Corporation TB42 SN8AA Free Piston Stirling Cooler.

An Arduino thermocouple shield combined with 4 K-type thermocouples and an open source code was utilized to record temperature readings at 4 locations as shown in Figure 2. These included the cold head, the hot region, fin assembly, and ambient readings. Cold temperature reached down to  $-20^{\circ}\text{C}$ , where the hot temperature reached up to  $42^{\circ}\text{C}$  at the cylinder to  $32^{\circ}\text{C}$  at the outside of the fin assembly. As the energy required was only 40 Watt measured with a Kill A Watt monitor.





**Figure 2.** Arduino unit with thermocouple shield and K-type thermocouples.

Figure 3 shows a detailed cutaway illustration of the TwinBird cooler and will serve a guide to determine internal configuration of this project.



**Figure 3.** Cutaway photo of Twinbird Cryocooler

With respect to the engineering requirements found in Table 2, measured values for each constraint (provided) can and will be quantified through some experiment/testing procedure designed by the team. Namely, the vessel pressure will be measured using a pressure transducer that will be appropriately connected to an Arduino board. This pressure sensor will measure pressure over time and automatically record the data onto an SD card. The power input will be measured manually with the use of Kill-a-Watt device. The Regenerator Porosity and packing factor will be estimated by deciphering the volume of space the mesh is contained in as well as the geometrical properties of the wire and the screen's overlaying pattern. The insulation material's specific heat was given a target value to ensure the system is capable to operate under extreme conditions (i.e. high heat flux and temperatures). The regenerator material's conductivity & specific heat target values are associated with values found in the literature and will be used to identify the material used in the regenerator. Finally, the number of seals and the system volume are easily measured, while the frequency will either be measured manually or with a linear variable differential transformer.

## 2.4 House of Quality (HoQ)

The house of quality (HoQ) is used to relate engineering requirements with the customer needs and is displayed in Figure 1. Namely, the HoQ effectively ranks the correlation between each customer need and engineering requirement, based on a scale from one to nine. On this scale, one is the least related while nine indicates a strong correlation between the ER and the customer need. The absolute technical importance was calculated by first multiplying the score of 1-9 assigned between each ER and customer need, by the corresponding customer weight. After completing the products for one engineering requirement, the absolute technical importance was determined by summing all the products (for each ER).

**Table 3** House of Quality.

| Customer Needs                       | Customer Weights | Power Input | Regenerator Material Porosity | Regenerator Material Specific Heat (C_v) | Number of Seals | Frequency | System Volume  | Vessel Pressure | Regenerator Packing Factor | Insulation Material Specific Heat | Regenerator Conductivity |
|--------------------------------------|------------------|-------------|-------------------------------|------------------------------------------|-----------------|-----------|----------------|-----------------|----------------------------|-----------------------------------|--------------------------|
| Transfer Heat from cooler            | 5                | 9           | 7                             | 8                                        | 7               | 7         | 6              | 9               | 7                          | 9                                 | 9                        |
| Fits in Lab space                    | 4                |             |                               | 3                                        | 4               |           | 9              |                 | 3                          | 4                                 |                          |
| Externally Powered                   | 3                | 9           |                               |                                          |                 | 3         | 5              | 7               |                            |                                   |                          |
| Educational                          | 3                | 4           | 1                             | 1                                        | 4               | 1         | 5              |                 |                            |                                   |                          |
| Safety                               | 5                | 5           | 3                             | 3                                        | 4               |           | 1              | 8               | 2                          | 5                                 |                          |
| Cost                                 | 5                | 6           | 4                             | 5                                        | 2               |           | 1              | 3               | 1                          | 2                                 | 7                        |
| Durability                           | 3                | 4           | 2                             | 5                                        | 6               | 5         |                | 5               | 2                          | 7                                 | 2                        |
| Manufacturability                    | 4                | 3           |                               |                                          | 6               | 1         | 6              | 4               |                            |                                   |                          |
| <b>Technical Requirement Units</b>   |                  | kW          | -                             | J/g K                                    | #               | Hz        | m <sup>3</sup> | MPa             | -                          | kJ/kg *K                          | W/m *K                   |
| <b>Technical Requirement Targets</b> |                  | 2           | 40                            | 0.4                                      | 4               | 30        | 0.1            | 1               | 40                         | 0.4                               | 14                       |
| <b>Absolute Technical Importance</b> |                  | 163.00      | 79.00                         | 110.00                                   | 135.00          | 66.00     | 130.00         | 152.00          | 68.00                      | 117.00                            | 86.00                    |
| <b>Relative Technical Importance</b> |                  | 1           | 8                             | 6                                        | 3               | 10        | 4              | 2               | 9                          | 5                                 | 7                        |

The HoQ indicates that compression/expansion space is one of the important, since it has that highest absolute technical importance. Other notable ERs that were found to be important with the HoQ are Fin effectiveness and Power input. It is also worth noting that the relative technical importance ranked the ERs based on their absolute technical importance, with one

being the most important. With this tool, the team will now focus on optimizing features of our design that are at all related to power input, fin effectiveness and compression/expansion space. These features can be derived intuitively or be based on the HoQ. In the future, ERs can be correlated to themselves to determine how strongly each ER is related to one another.

### **3 EXISTING DESIGNS**

Industrial uses of Stirling cycle cryocoolers is extensive. Examples of existing designs include each of the following system designs including Alpha, Beta, Gamma, and Free piston types. Research focused on each system is described in section 3.1 is followed by system level descriptions and figures that explain each design.

#### ***3.1 Design Research***

Research processes for this project include looking at existing designs kindly provided by our client Dr. David Trevas who loaned a small model of a Stirling engine that operates using an alcohol fueled candle as a heat source. Although the model is an engine, it does help demonstrate the relating features that are included in Stirling coolers such as the piston, displacer, regenerator, and differential heat requirement. A similar, yet more simplistic model, was purchased by the team to help explore various designs.

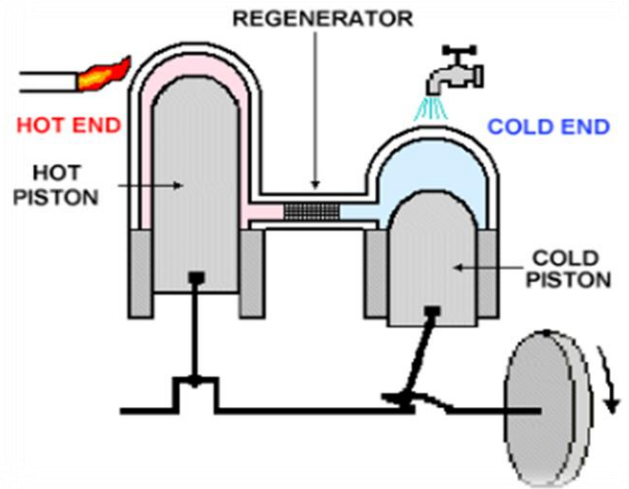
Viewing demonstrations posted to YouTube have been studied to gain understanding of various processes and applications that have been designed produced for industrial consumption. Many peer reviewed journal articles exist that have been reviewed and referenced along with several books that were obtained from Cline Library. Leading research conducted by Israel Urieli and William Beale Ohio University has been reviewed and referenced extensively since these sources were leading authority and pioneers of Stirling systems as well as personal acquaintances of our client Dr. Trevas.

Benchmarking was guided by interviews with our project mentor, Mr. David Willie. Professor Willie has conducted extensive research on Stirling engines and coolers and was employed by the Sunpower Company that specializes in production of Stirling technologies focusing on environmentally responsible alternatives to power generation and refrigeration applications.

#### ***3.2 System Level***

##### **3.2.1 Existing Design #1: Alpha**

The simplest design of Stirling engines, conceptionally is the alpha engine, and the alpha engine depends on two pistons separately, and both pistons are large. T shape and both are in downward shape [1]. Alpha engine works on the principle of cyclic compression and expansion. The hot piston is larger than the cold piston in this design [1]. These two pistons serve to remove heat from the expansion space. This design will help us in making the Stirling cryocoolers and we can take the concept of this alpha engine design for the implementation of our project. The specific alpha design is shown in the following figures.



**Figure 4:** Alpha engine existing design 1 [1]



**Figure 5:** Alpha engine existing design 1 [1]

The alpha engine could work in the same way as a refrigerator (except in reverse) by compression and expansion of cold and hot reservoirs. The features contained in the alpha engine can be utilized in the project, with some modification, because this engine utilizes the Stirling cycle. Higher compression ratios provided by the alpha engine, which consists of two separate pistons, can be utilized into this project to improve upon the performance of the cycle [1].

This configuration requires the implementation of a flywheel (see figure 4) which is distinguishable from designs that use a linear motor. Additionally, this design does not require

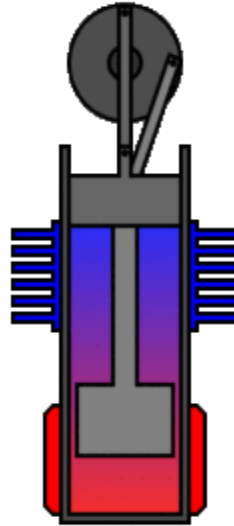
the inclusion of a displacer (used in the beta and gamma configurations). Most existing designs of Alpha configuration engines are used for power generation or demonstration (Figure 6), no references were found using this type as a cooling application. The design in (Figure 6) is a demonstration of an alpha design you can purchase from Amazon, by lighting the candle the two pistons will work together and generate power to light the lamp this is a demonstration of a symbol alpha engine that helping new students to learn how alpha engine works, by using candle and lighting the lamp we can observe how much the engine generate power, and will it last longer.



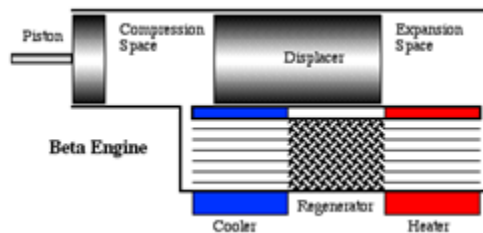
**Figure 6.** Model of alpha type Stirling Engine [2].

### 3.2.2 Existing Design #2: Beta

An important early Beta engine is Lehmann's machine on which Gustav Schmidt did the first reasonable analysis for in 1871. Andy Ross built a small working replica of the Lehmann machine, as well as a model air engine, both based on single cylinder Beta configurations [3]. Figure 7 and 8 show basic configuration of the Beta type engine.



**Figure 7:** Beta type Stirling engine [3]



**Figure 8:** Schematic of Beta type Stirling engine [3]

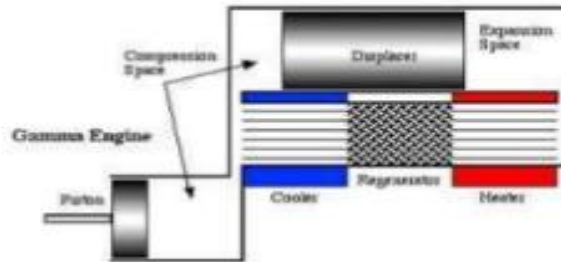
For the Beta configuration, the piston and displacer share the same cylinder and connected to a flywheel and motor. It does meet the requirements we have for our cryocooler engine to work. For our beta design we would use electric motor as our energy source. Also, we would be using fins to increase the rate of heat transfer.

This beta configuration has a flywheel which provides the rotation to piston that produce the compression and expansion. Flywheel plays the same role in the beta configuration as it plays in other types since its function is to produce rotational motion and cause the piston (and displacer) to move up and down. This design for the beta configuration is useful for our design process and we can further develop and modify the concept of flywheel with the beta configuration for our design.



### 3.2.3 Existing Design #3: Gamma

Another existing design relating to our project is gamma configuration (Figure 9). An existing design of the gamma configuration is shown in the figure below. The gamma configuration is one of four existing designs. It is the simplest design of a Stirling cycle, in which a small piston is used for compression. This configuration consists of a piston moving in the horizontal direction [4]. This configuration is used in other existing designs and is available commercially (to purchase).



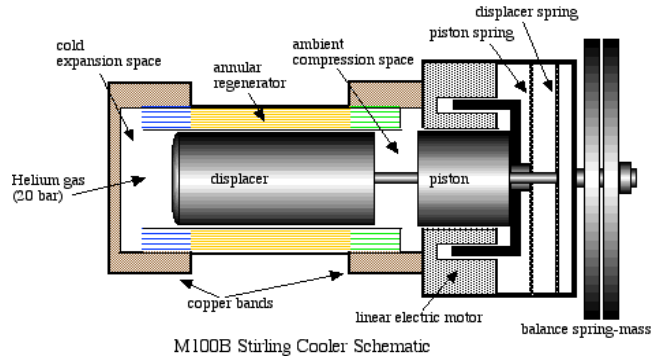
**Figure 9:** Gamma engine existing design 3 [4]

A displacer is used in this design. Its purpose is to induce the motion of the gas and cause the gas to move between the hot and cold reservoir by exploiting the pressure drops induced by the cycle/temperature differential. The power piston is in a separate cylinder which is connected to the other cylinder as to provide a pathway for the fluid.

This design provides a low compression ratio due to its small piston and large dead volume. Furthermore, this configuration has the lowest characteristic efficiency, when compared to the other configurations, in general. The advantage of this configuration is that there is only one seal, which does serve to satisfy one of our ERs.

### 3.2.4 Existing Design #4: Free Piston

Common cryocooling devices that exist in industry rely on Free Piston Stirling Cooling (FPSC) mechanisms that prove effective and simple in design. These arrangements have fewer moving parts and rely on simplified configurations to achieve effective cooling processes. Existing cryocooler applications that utilize this design include medical specimen transport coolers [5], gas liquification and purification systems [5], aeronautical/space vehicle climate control [6], and carbon dioxide capture [7].



**Figure 10:** Schematic of Free Piston cooler [8].

Free piston designs are relatively simple and require only two moving parts. Figure 10 shows a simplified arrangement of a free piston assembly combined with a linear motor configuration. The displacer and piston are linearly oriented along a common shaft while the regeneration process occurs in the annular space surrounding the main cylinder. Helium or air acting as working fluid is shuttled from cold to hot by motion of the displacer by way of the regenerator. Compression is applied by the piston and heat is dissipated and transferred to the surroundings via fins. The gas can expand in the cold space while the heat is removed from the gas in the regenerator media [8]. Springs are attached to the end of the shaft act as shock absorbers and produce a rebounding force to continue reciprocating motion to execute heat removal process.



**Figure 11:** Shuttle ULT-25N Ultra-Low Temperature Freezers, Stirling Ultracold # ULT25EXT (10027-524) - Model ULT-25N [9]

An example of a cooling device that uses Stirling cooling technology is manufactured by the Shuttle company and shown in Figure 11. This product is used for medical transport and provides solid function and proven performance. This design can be used as a benchmarking standard that is applicable to this project. However, the temperature range that this product provides is much

lower than what the customer requirements require. Figure 11 shows the portability and functional cold storage that can be incorporated into this design.

Bench top cryocoolers could be displayed with transparent mounting and equipped with monitoring instrumentation that displays amperage and temperature readings provided by multimeter and thermocouples. Existing arrangements of this type are rare but could be assembled using combinations of necessary devices that can be purchased. Figure 12 shows two critical components, cryocooler and power drive that could be attached to a framework constructed from clear acrylic material.



**Figure 12.** Twinbird Corporation, *Stirling Cooler Model: SC-TD08*. [10]

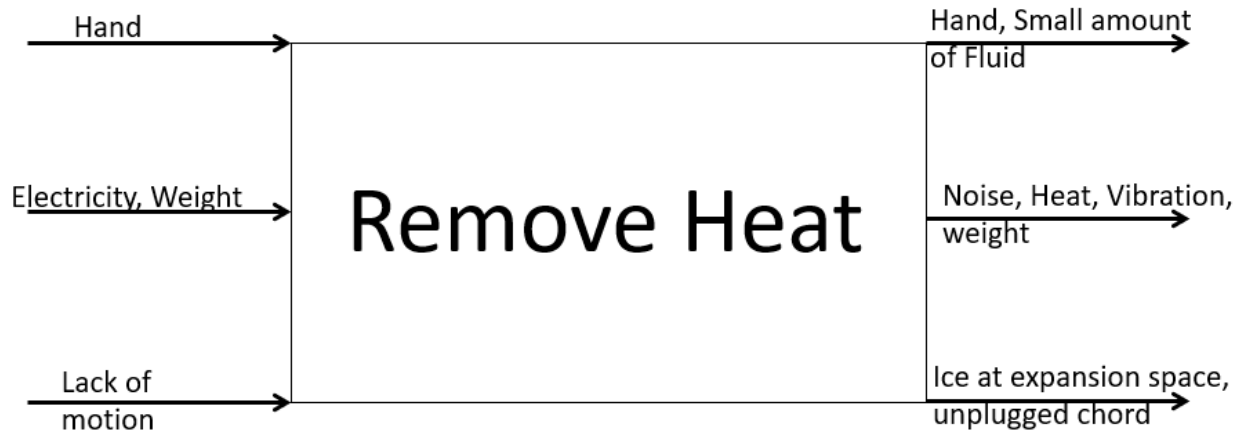
This Stirling cooling process suits the needs of this project to provide ample cooling to meet customer needs. Possible experimental lab assignments using this device include investigations relating power input to temperature change rate, working fluid properties, changing working fluid types, power source alternatives, thermodynamic processes observation and optimization. Simple display and arrangement of this type of cooling system design will easily be displayed in a benchtop configuration and could possibly be constructed from transparent materials that would allow a deeper understanding of the internal movement and function of the Stirling process.

### **3.3 Functional Decomposition**

The following sections describe the functional decomposition of the Stirling Cryocooler system using black box and functional model design tools. Functional modeling created design factors that are eventually eliminated from initial concept and provided a method of choosing the proposed design mentioned in chapter 6.

#### **3.3.1 Black Box Model**

The black box model was developed for a Stirling refrigeration system by first conducting some background research. After understanding a comprehensive overview of the system, the group identified the inputs and outputs of the overall system (Figure 13).



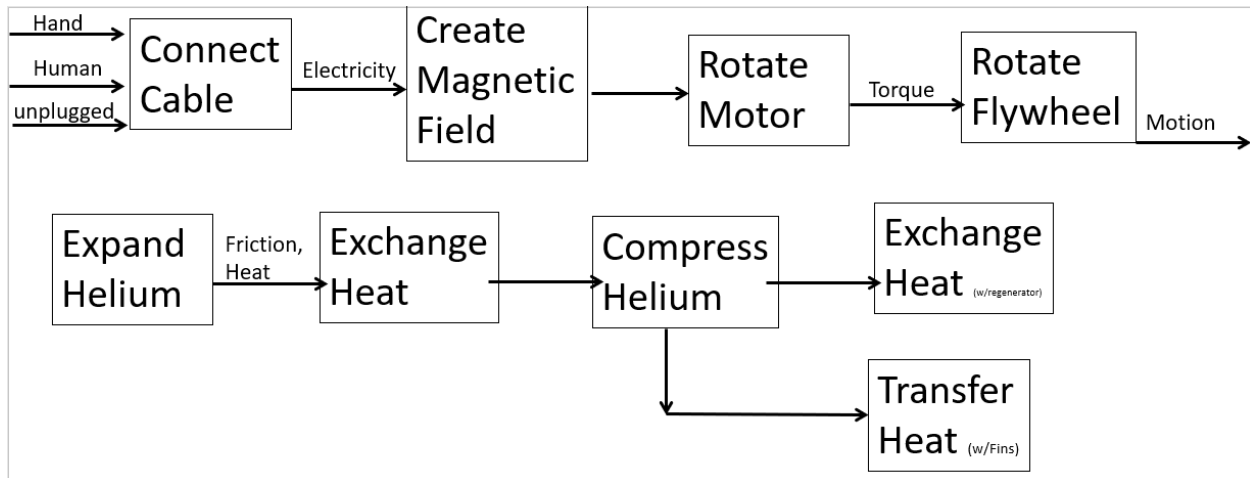
**Figure 13: Black Box Model**

The black box model was developed for a Stirling refrigeration system by first conducting some background research. After understanding a comprehensive overview of the system, the group identified the inputs and outputs of the overall system. The inputs included a hand to plug in the power, electricity to power the motor, the weight to be oriented in an appropriate fashion and the lack of motion to indicate that the system is not in operation. The outputs include hand that is being removed, fluid that is leaking from the system, noise, heat and vibration stemming from the motor/system's imperfections. The presence of ice near the expansion space would indicate that the system worked, and the unplugged chord would indicate that the system is off.

### **3.3.2 Functional Model**

This functional model was developed by using the inputs and outputs from the black box model and expanding on it (Figure 14). The following sequence of events are represented in the Functional Model in Figure 14. Namely, cable is connected to the wall to supply electricity to the motor, which will create a magnetic field that induces rotational motion. This motion will drive the flywheel and cause a piston to expand the working fluid. The action performed by the piston will lead to energy inefficiencies (i.e. friction & heat) which will affect the system's overall performance. The motion of the flywheel will then induce the motion of the working fluid to travel through the regenerator and exchange heat with the regenerator material. Subsequently, the fluid will be compressed by a piston and will lose energy in the form of heat, through its fins. The cycle then continues by the working fluid being forced through the regenerator again for another exchange of heat.

These functional decompositions provided influence on design by highlighting extra parts, such as the flywheel and linkage to pistons, working fluid analysis and determination. Looking at what can meet customer and engineering needs showed how these functional decompositions were important.



**Figure 14:** Functional Model

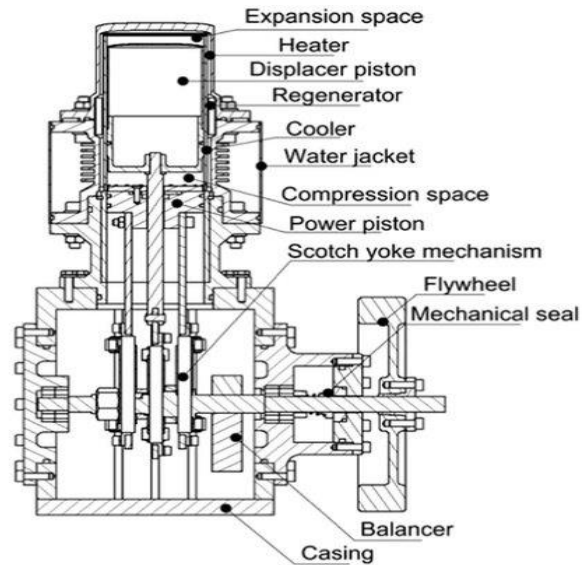
### 3.4 Subsystem Level

Subsystems of the Stirling Cryocooler exist in similar configurations among each system type. Displacers, pistons, seals, regeneration sections, and working fluid are similar for each system and perform the same function in each. The following sections describe in detail the individual working of each subsystem followed by examples of existing designs as they pertain to a Stirling cycle cooling device.

#### 3.4.1 Subsystem #1: Displacer

Stirling cooler designs utilize displacers as a means of transferring the working fluid between the cold and hot regions of the device. The importance of this subsystem is critical to the basic operation of any Stirling engine or cooler. The displacer provides no work since the pressure of the working gas remains constant on either side of the displacer piston [11]. The working gas is transferred from hot to cold zones by ducts that are incorporated within the displacement cylinder that house the regeneration material. Figure 3 shows this system as it applies to a free piston system.

Project requirements are met by including an effective displacer subsystem that plays a key role in the Stirling cooling cycle. Transference of working gas from the hot to cold areas of the assembly along with the position of these zones is critical to the effective cooling characteristics of this model. Movement of the Displacer piston is explained in section (3.4.5.4) referencing the linear motor description. The design of this motion combined with a notably longer size and thinner wall thickness is primarily to isolate the two thermal regions and minimize conduction between the two [1]. Figure 15 shows an example for subsystem level of displacer. Stirling cooler have that system including Alpha, Beta and Gamma it has been explained in section (3.2(1,2,3)). In that section showing how is displacer work.



**Figure 15** Stirling engine with Scotch yoke drive mechanism

### 3.4.2 Subsystem #2: Piston

Each configuration must achieve the compression stage of the Stirling cycle using a piston that is attached to the reciprocating shaft much like the other systems. Its purpose is to create pressure on the forward stroke and receive force from expanding gas pressure which in turn translates to torque or is absorbed by a spring. The figure below explains how the piston works. In free piston it works with empty area. In the begging there is area have fluid gas that is the light gas used in cryocooler. There will be pressure added to the fluid containing area from two-way displacer and piston.

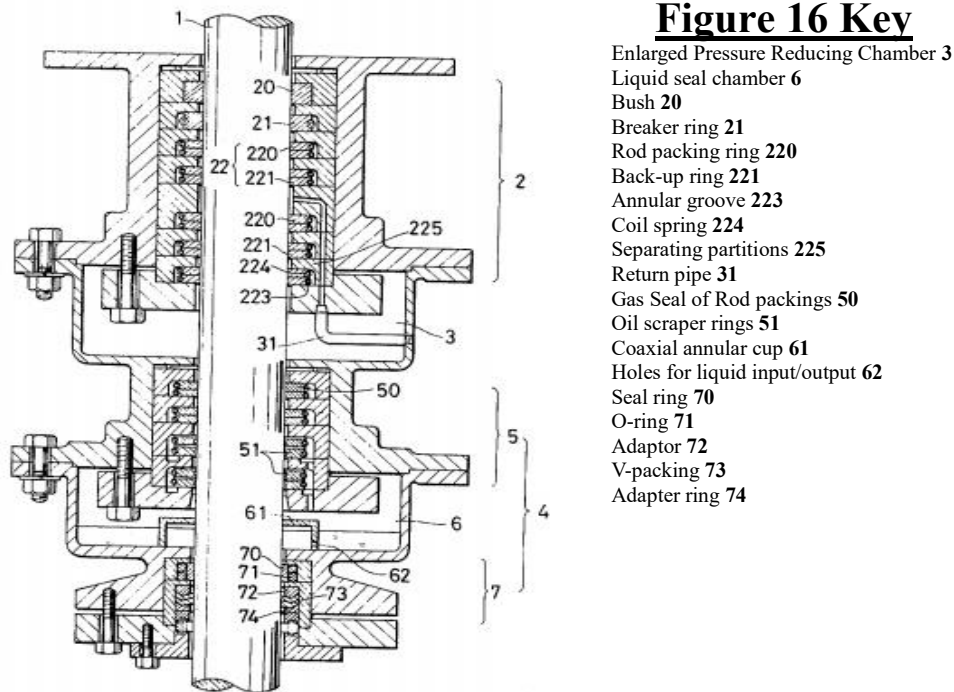
### 3.4.3 Subsystem #3: Flywheel

It is the sub-system in the engine, which rotates with the help of some external source or from the internal source and flywheel uses to rotate the piston connects with it. It stores the rotational energy and it stores the inertia as well during the rotation. Moment of inertia cause the flywheel to keep rotating and moving the piston to create the expansion and compression. Flywheel needs the torque to rotate and that torque provides initially from external source and then because of moment of inertia it needs little amount to torque to keep rotating. It should also be noted that this component is not necessary for every design (e.g. Refrigerator powered by a linear motor).

### 3.4.4 Subsystem #4: Gaskets & Seals

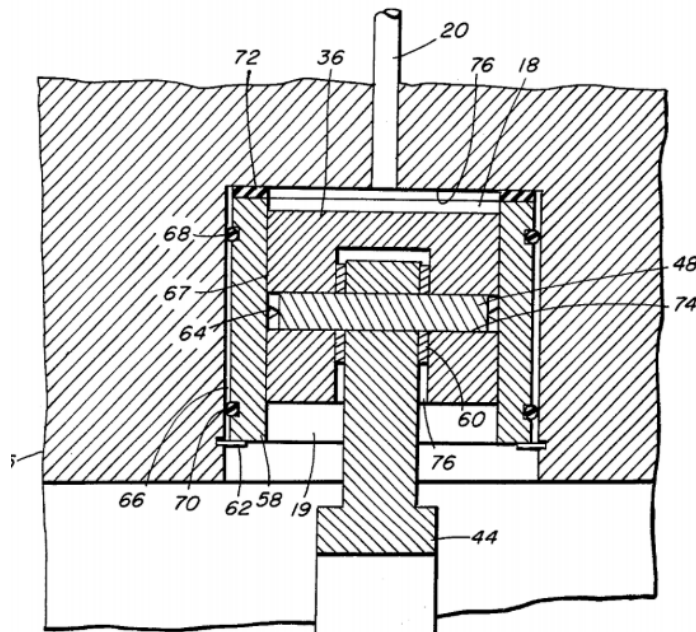
Efficient compression in the free piston system depends on effective seals between the piston and cylinder. This project will require seals that allow enough pressure to conduct the compression stage of the Stirling cycle while offering minimal resistance due to friction. Even the slightest amount of working fluid leakage dramatically decreases the ideal cold production [12]. When common seals like lip and ring seals are used, Stirling refrigerators often are troubled

by working fluid leakage past the dynamic seal [13]. This leakage will cause a decrease in the mean pressure of the working fluid, which is known to deteriorate the seals over time, inducing a coupled decrease in the efficiency of the refrigerator [13]. As can be inferred, seals are a vital component in a Stirling refrigerator due to its function in preventing contamination as well as leakage of working fluid.



**Figure 16:** Piston Rod sealing arrangement from Eisuke Sugahara [14]

Figure 16 shows a possible sealing arrangement for a system using a reciprocating Stirling cycle. This arrangement is comprised of a block seal port, a bush, breaker ring, and block seals [14]. The breaker ring is lubricated and helps the bush prevent leakage of the working fluid [14]. The rod packing ring contacts the rod and the back-up ring contacts the rod packing ring [14]. The oil scraper rings contact the piston rod to block the escape of fluid in the liquid seal chamber [14]. The liquid used in the arrangement (specifically in 6) should have a “low affinity for the piston rod material, a high viscosity, and large surface tension” (e.g. Mercury or oil) [14]. It should also be noted that liquid diffusion up the piston rod will be prevented by the oil scraper rings [14]. The most notable aspect about this design is the presence of a gas recirculation system in place to lead leaked gas into the return pipe to a compressor and finally into the working cylinder through the mechanism of a pressure sensitive control valve [14].

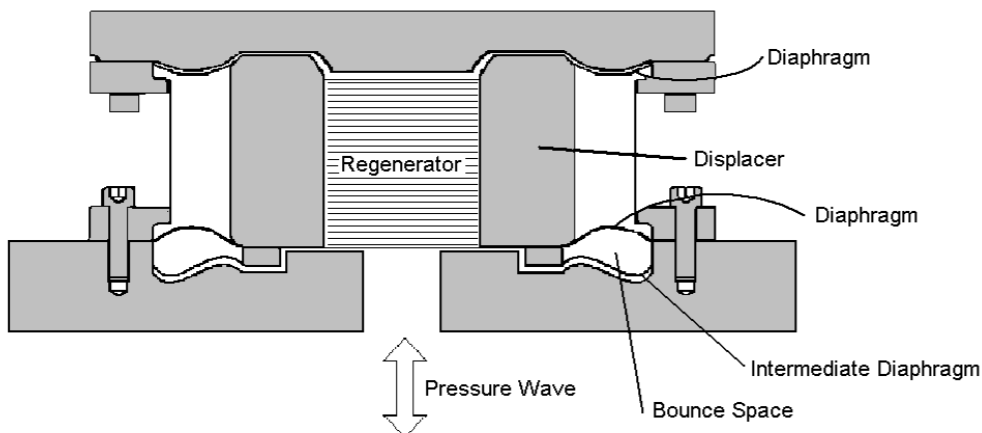


**Figure 17 Key**

- Working Gas Space 18
- Dead Space Volume 19
- Supply Line 20
- Cermet Piston 36
- Connecting Rod 44
- Wrist Pin 48
- Ceramic Sleeve 58
- Spacers 60
- Snap Ring 62
- Pressure Equalization Groove 64
- Radial Clearance/Gap 66
- Clearance Seal 67
- Gas Blow-by Elastic O-ring 68
- Dead Space Minimizing Elastic O-ring 70
- Sleeve Elastic O-ring 72
- Wrist Pin Bearing 74
- Surface 76

**Figure 17:** Clearance Seal & Piston Arrangement Drawing [13]

Figure 17 above shows an example of a Clearance piston seal invented by Peter Bertsch. The piston is of cermet or ceramic and reciprocates within a ceramic sleeve [13]. The use of ceramic is instrumental in providing a smooth surface, while the radial gap is filled with the working fluid to act as a lubricant and minimize wear [13]. The snap ring keeps the sleeve in place, with some freedom for thermal expansion supplied by the elastic O-rings [13]. The Floating sleeve also serves to absorb some of the load created in the reciprocating motion [13]. This patent also mentions that this mechanism can be used with a displacer in this kind of system, as well [13].



**Figure 18:** Diaphragm-contained displacer [15]

The above Figure 18 shows an alternative to conventional lip seals and piston rings. Specifically, A. Caughley et al described a “concept of using metallic diaphragms to seal and support the displacer in a free piston Stirling cold head” [15]. This reference describes the diaphragms as functioning to seal and suspend the displacer while also balancing the compressive loads



subjected to the displacer [15]. These diaphragms' stiffness is such that it provides spring-like characteristic to center the displacer [15]. This type of design would minimize the amount of seals we might need, while also eliminating the clearance gaps and rubbing [15].

### **3.4.5 Subsystem #5: Fin Types**

For a Stirling refrigeration cycle, the objective is to move heat against a temperature differential. Moving heat against the temperature gradient requires an input of work. The larger the temperature gradient, the more work required to be inputted to the system. To minimize the power consumption of the refrigeration system, one must attempt to maintain and/or decrease the temperature gradient between the hot and cold reservoirs. To prevent the hot reservoir from increasing temperature over the course of the cycle(s), one can implement fins on the outside surface of the hot reservoir. The implementation of fins on this surface will allow for the hot reservoir to dissipate heat to the atmosphere at a high rate, due to fins' high wetted area. Different fin types can be found in the book Fundamentals of Heat and Mass Transfer, where their effectiveness, efficiency, and relevant geometric considerations can be quantified [16].

There are straight, circular and pin fins. While circular fins don't get any more specific, the straight and pin fins can be rectangular, parabolic or triangular. While parabolic has the highest heat transfer per unit volume compared to the other fins, the manufacturing costs associated with fabricating a parabolic profile outweighs the superior heat transfer rate. Manufacturing costs are why simpler geometries are elected over more complex ones, despite heat dissipation advantages. Figure 19 below shows the different pin fins and their respective geometric considerations.

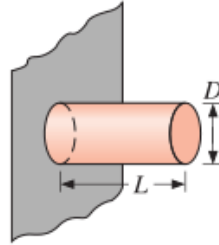
### Pin Fins

#### Rectangular<sup>b</sup>

$$A_f = \pi D L_c$$

$$L_c = L + (D/4)$$

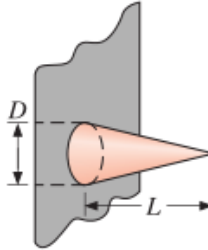
$$V = (\pi D^2/4)L$$



#### Triangular<sup>b</sup>

$$A_f = \frac{\pi D}{2} [L^2 + (D/2)^2]^{1/2}$$

$$V = (\pi/12)D^2 L$$



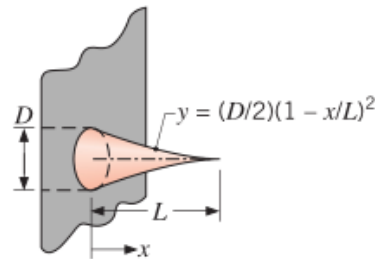
#### Parabolic<sup>b</sup>

$$A_f = \frac{\pi L^3}{8D} \{C_3 C_4 - \frac{L}{2D} \ln [(2DC_4/L) + C_3]\}$$

$$C_3 = 1 + 2(D/L)^2$$

$$C_4 = [1 + (D/L)^2]^{1/2}$$

$$V = (\pi/20)D^2 L$$



---

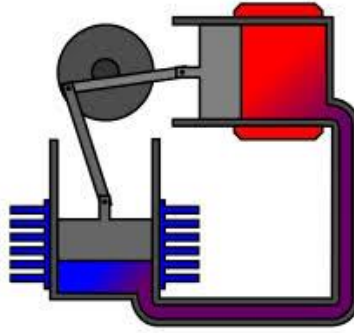

$${}^a m = (2h/kt)^{1/2}$$

$${}^b m = (4h/kD)^{1/2}$$

**Figure 19:** Pin Fin Variations. [16]

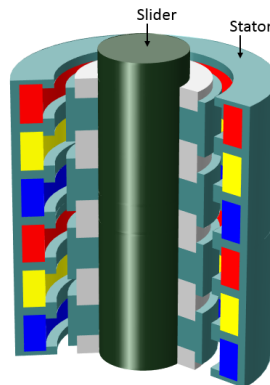
### 3.4.6 Subsystem #5: Linear/Rotary Motor

Using a linear motor is a common source of piston actuation in free piston system. Many types of linear type electric motors are available with a range of actuation displacement. This project proposes either the use of a high efficiency, small volume, linear motor (Figure 21) or a rotary motor that utilizes that would require a flywheel and connector rods (Figure 20). Both types are feasible however the linear motor would allow for a more compact “built-in” aspect rather than an extensive connection assembly that requires more space, parts and ultimately, cost.



**Figure 20:** Idealized flywheel, connectors, piston and displacer assembly for Alpha system. [17]

Piston actuation is the primary goal of either the linear or rotational electric motor. Displacer and piston motion generally actuate in a synchronized and unilateral manner. A rotational motor type is feasible to reach system design requirements for the Alpha, Beta, and Gamma configurations. Since they rely on separate piston/cylinder configurations requiring connector arms attached to a flywheel. The Free Piston system commonly uses linear motors to achieve shaft motion that results in piston/displacer motion (Figure 21).



**Figure 21:** A 3D view of the tubular generator [18]

Electrical needs for this project place motor requirements to be able to receive power from a standard 120 volt alternating current outlet. Project variations may require motors that could utilize 12v direct current that allows for either solar or vehicular alternative power sources.

### 3.4.7 Subsystem #6: Regenerator Material

The regenerator in a Stirling refrigeration system serves to act as a thermal sponge in the scheme of the cycle. Namely, the regenerator matrix will function to accept heat from the working fluid when it is translating from the hot reservoir (compression space) to the cold reservoir (expansion space) and reject heat to the working fluid when it is moving in the opposite direction (expansion to compression space). As such, properties that are relevant to the optimization of this system include heat capacity, porosity, and density of the regenerator material. Additionally, the size of the regenerator and the viscosity of the working fluid will certainly affect the regenerator's performance.

It should also be noted that the regenerator is one of the most important components in a

Stirling refrigerator. Namely, the regenerator is typically the largest source of power loss in the system, due to “Axial heat conduction, imperfect gas–solid heat transfer, and frictional losses” [19].

The heat capacity of the regenerator material should be maximized as to maximize the amount of heat energy extracted from the working fluid and by extension, to minimize the temperature of the working fluid when it enters the expansion space. Conversely, a high heat capacity of the regenerator material will also allow for more heat energy to be potentially transferred to the working fluid on its path to the compression space, where heat dissipation to the environment will be exploited using fins.

It is known that the pressure drop across a porous media is related to the viscosity & porosity of the solid phase [19]. Namely, the higher the viscosity, the higher the associated pressure drop. This relation is provided below in Equation 1, where the above proportions can be extracted from. It should be noted that pressure drops are associated with an increase in power consumption, which is not desirable [19].

$$\frac{dp}{dx} = -\frac{\mu}{K}\varepsilon u + \frac{c_f \rho}{\sqrt{K}}\varepsilon^2 u|u| \quad \text{Equation 1 [19]}$$

Additionally, the above equation states that density is directly proportional to the pressure drop, which might indicate that we want to minimize the density. Increasing the density will also increase the heat capacity of the solid phase as well as the working fluid’s flow impedance. With opposing property optimizations, the density will be optimized by paying attention to the other optimizable characteristics and properties of the system.

Porosity should be maximized to decrease flow impedance and to maximize the rate at which heat is transferred to and from the solid phase. Equation A also indicates that the pressure drop magnitude increases as porosity increases. Moreover, minimizing the size of the regenerator subsystem will minimize the heat dissipation from the system to the atmosphere (heat leakage), minimize the flow impedance that the working fluid is subjected to (through the regenerator material’s boundary layers) and minimize the dead volume, which is directly related to the overall efficiency of the refrigeration. It should also be noted that the longer the regenerator, the bigger the pressure drop across the regenerator [19].

There are a variety of different materials and configurations used in regenerators. Examples of solid matrices used in regenerators include wire-mesh screens, perforated disks, spherical powders, foam metal, foils and composites [19]. Wire mesh screens are the most common among Stirling refrigerators, which come in two varieties: plain and twill [19].

As far as optimizing the geometric considerations of a wire-mesh screen are concerned, the length and diameter of the wire are the relevant dimensions with respect to the regenerator’s performance.

Namely, as the ratio of the length to the diameter of the wire  $\left(\frac{L_w}{D_w}\right)$  increases, the convective heat transfer coefficient and area increase. The increase in the convective heat transfer coefficient and area also indicates that there will be a corresponding increase in the heat transfer from the fluid to the solid (and vice-versa) [19]. Additionally, increasing the wire diameter at a given  $\frac{L_w}{D_w}$  ratio and decreasing the  $\frac{L_w}{D_w}$  ratio at a given wire diameter results in a decrease in the frictional power dissipation and compressor power consumption. As wire

diameter increases, the compressor's power consumption decreases while the pressure drop's magnitude will increase due to an increase in porosity for larger wire diameters [19]. These contrasting relations infer the fact that for a given  $\frac{L_w}{D_w}$  ratio, there exists a unique wire diameter that corresponds to a maximum value for the coefficient of performance (COP) [19].

NASA's contract report ("Composite Matrix Regenerator for Stirling Engines") provides the following tables that shows the relevant material properties for different regenerator materials:

**Table 4** Material Properties of Selected Regenerator Materials at T = 750K [20]

| Material            | $k$      | $d$                  | $c_p$   | $c$                    | $kc$  | $k/c$ | $kc$                  | $k/c$ |
|---------------------|----------|----------------------|---------|------------------------|-------|-------|-----------------------|-------|
|                     | (W/K-cm) | (g/cm <sup>3</sup> ) | (J/g-K) | (J/cm <sup>3</sup> -K) |       |       | (normalized to steel) |       |
| Stainless Steel     | 0.14     | 8.00                 | 0.66    | 5.28                   | 0.74  | 0.027 | 1.00                  | 1.00  |
| Graphite (crystal)  | 5.20     | 2.10                 | 1.81    | 3.80                   | 19.77 | 1.368 | 26.74                 | 51.60 |
| Carbon (amorphous)  | 0.02     | 2.10                 | 1.81    | 3.80                   | 0.09  | 0.006 | 0.12                  | 0.24  |
| Silicon             | 0.30     | 2.33                 | 0.94    | 2.19                   | 0.66  | 0.137 | 0.89                  | 5.16  |
| Boron               | 0.06     | 2.34                 | 2.32    | 5.44                   | 0.34  | 0.011 | 0.46                  | 0.43  |
| Beryllium           | 0.87     | 1.85                 | 3.05    | 5.64                   | 4.90  | 0.154 | 6.63                  | 5.80  |
| 50%Graphite/Carbon  | 2.61     | 2.10                 | 1.81    | 3.80                   | 9.93  | 0.687 | 13.43                 | 25.92 |
| 50%Graphite/Boron   | 2.63     | 2.22                 | 2.08    | 4.62                   | 12.15 | 0.570 | 16.44                 | 21.48 |
| 50%Graphite/Silicon | 2.75     | 2.22                 | 1.35    | 3.00                   | 8.24  | 0.918 | 11.15                 | 34.61 |

**Table 5** Carbon and Steel Thermal Properties [20]

| Material            | heat capacity (J/K-g) | thermal conductivity (W/K-m) | density (kg/m <sup>3</sup> ) |
|---------------------|-----------------------|------------------------------|------------------------------|
| felt carbon         | 0.712                 | 0.035                        | 1570                         |
| 316 stainless steel | 0.494                 | 16.23                        | 9058                         |
| Inconel-600         | 0.456                 | 15.00                        | 8498                         |

According to Q. Zhou, L. Chen et al,  $Er_3Ni$  is a great material for regenerators operating at a temperature of 20 K because of its high ratio of thermal conductivity to specific heat capacity [21]. Its thermal diffusivity is comparable to that of a stainless-steel wire mesh, while its flow resistance is much larger than that of a stainless-steel wire mesh (especially for spheres with diameters less than 100  $\mu$ m) [21]. Finally, Q. Zhou, L. Chen et al compared 500-mesh SS plus

9mm  $Er_3Ni$  to 500-mesh SS and the following results were obtained [21]:

**Table 6** Performance of Different Regenerators [21]

| Regenerator materials | no-load temperature | Optimum frequency |
|-----------------------|---------------------|-------------------|
| /                     | K                   | Hz                |
| 500-mesh SS           | 17.4                | 35.5              |
| 500-mesh SS+ $Er_3Ni$ | 16.5                | 31.5              |

M. Tanaka, I. Yamashita, and F. Chisaka presented the geometric parameters relevant for the different regenerator materials they investigated, which are provided below in Table 7 [22].

**Table 7** Tested Regenerator Materials [21]

| Material       | Symbol | Dia. (mm) | Porosity* (-) | Porosity** (-) |
|----------------|--------|-----------|---------------|----------------|
| Wire Netting   | WN 50  | 0.23      | 0.645         |                |
|                | WN100  | 0.10      | 0.711         |                |
|                | WN150  | 0.06      | 0.754         |                |
|                | WN200  | 0.05      | 0.729         |                |
| Sponge Metal   | SM15   | 0.30      | 0.956         | 0.920          |
|                | SM30   | 0.14      | 0.936         | 0.897          |
|                | SM50   | 0.08      | 0.940         | 0.903          |
|                | SM50a  | 0.08      | 0.887         | 0.806          |
|                | SM50b  | 0.08      | 0.819         | 0.702          |
| Sintered Metal | SB     | 0.45      | 0.372         |                |

\* Calculated from bulk density

\*\* Calculated from water replacement

Finally, Table 8 shows more materials that could be used for the regenerator, which was taken directly from the literature [23].

**Table 8** Additional Regenerator Material Properties [23]

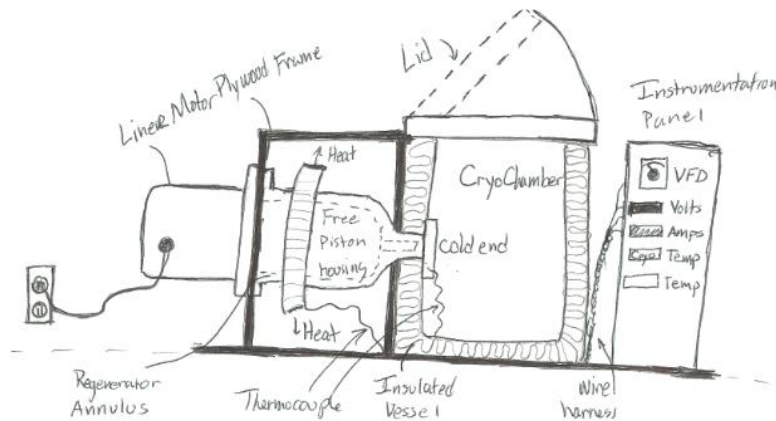
| Matrix no.                                 | 1                                 | 2                     | 3                         | 4                      | 5                                      |
|--------------------------------------------|-----------------------------------|-----------------------|---------------------------|------------------------|----------------------------------------|
| Material                                   | Stainless steel screens mesh #400 | + Cu screens mesh #80 | + Brass screens mesh #353 | + Perforated Cu-plates | + Brass screens + perforated Cu-plates |
| Length fraction (%)                        | 100                               | 50                    | 45                        | 4                      | 15 + 2                                 |
| Porosity of added component                | 0.59*                             | 0.62                  | 0.62                      | 0.20                   | 0.62                                   |
| Total radial conductivity at 100 K (W/m K) | 3                                 | 89                    | 15                        | 18                     | 25                                     |
| Total axial conductivity at 100 K (W/m K)  | 0.7                               | 1.4                   | 1.3                       | 0.8                    | 0.9                                    |

## 4 DESIGNS CONSIDERED

Benchmarking research demonstrated the existence of designs that are currently used for cooling purposes that use Stirling technology. Group brainstorming activities resulted in the following designs for this project. The top four are listed in sections 4.1 thru 4.1. More designs are listed in the appendix of this report.

### 4.1 Design #1: Benchtop Apparatus

This idea incorporates a recreation of existing Stirling cooler apparatus and incorporates a framework that the unit is mounted to. Power would be provided from a standard 120-volt outlet to power a linear motor connected to the free piston system as described in section 3.2.4. The device would be arranged so that multiple thermocouples could be attached at both cold and hot regions of the cooler. Voltage, amperage, and motor speed monitors including digital readout will be mounted to the frame assembly. Motor speed will be regulated using a variable frequency drive (VFD) attached to the frame.

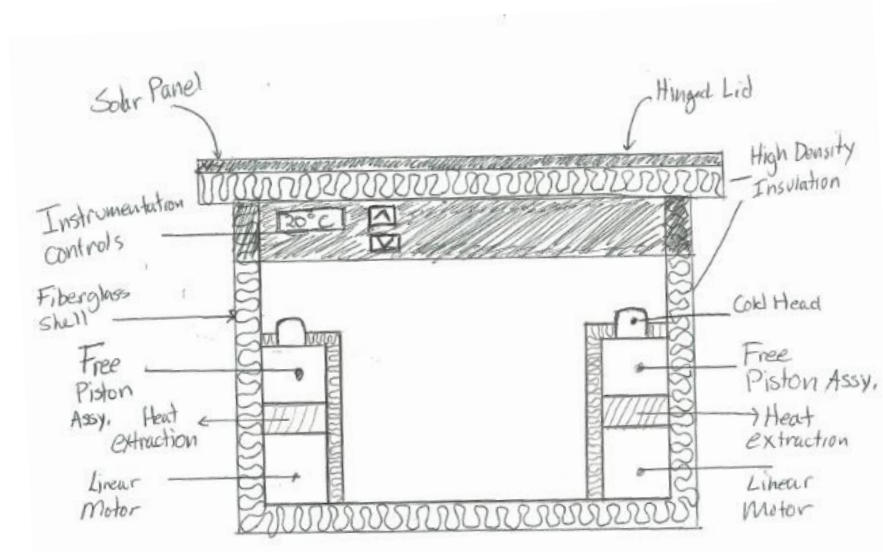


**Figure 22:** Benchtop concept with instrumentation panel and cold chamber.

Advantages of this design include functionality as a demonstration tool, efficiency regarding fewer moving parts, portability, and adaptable to different experiment designs. Data can be gathered from multiple thermocouples placed in critical locations along with voltage inputs from the motor. This data can be compiled by LabVIEW software that can be directly monitored via USB or better port. Disadvantages would begin with a high cost of materials and instrumentation components. Complication of connections and proper power sizing, transformers, VFD drive requirement would also add to difficulty of successful design.

### 4.2 Design #2: Solar powered Ice-Chest

Creation of cold space in sunny hot environments can be accomplished using a solar powered Free Piston Cryocooler. This design would require a very well insulated, air tight, cooling vessel that incorporates one or more linear motor actuated Stirling coolers. Solar panels that are attached to the cooler lid would provide power to the linear motor(s) and any other control instruments.



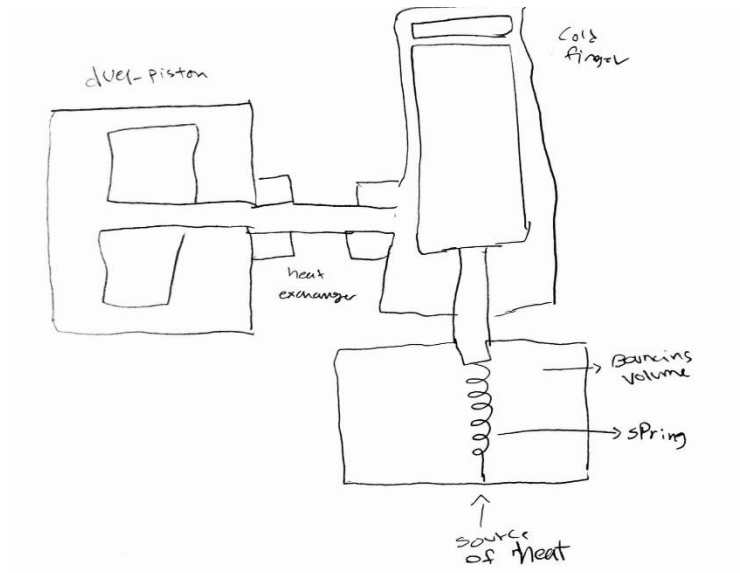
**Figure 23:** Solar powered Ice-Chest.

Self-sustaining cooling using solar radiation is a challenge that would be met by this design concept with vigor. Having the ability to generate low power consuming electric motors and eliminating dangerous refrigerants, complete freedom to keep items cold would be achieved. Advances in motor efficiency, thermo insulation, and photovoltaic panels could make this design feasible. Challenges include keeping consistent temperatures when sun is not present. Utilization of specialized insulating materials that are efficient enough to keep constant temperatures. Weight of the cooler in addition to contents, and cost.

#### **4.3 Design #3: Dual Piston Cryocooler**

This is a design in which there are two pistons connecting with the heat exchanger. A cold finger with the bouncing volume attached with the displacer, when the piston moves by the source of heat it creates the compression and expansion and cause the displacer to generate the power. The pros of this design are high power, low cost, and easy to operate. The con is that this design is less efficient. It can see in the following figure

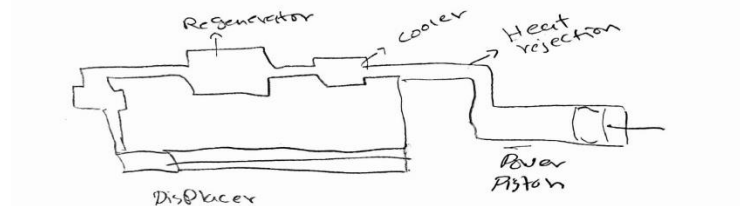




**Figure 24:** Dual piston

#### 4.4 Design #4: Inline regenerative cryocooler

In this design concept, there is a regenerator with the cooler in the single line, it has heat input and heat output with the displacer. In this system, the displacer connects with the heat input and the piston is in opposite to the displacer. Heat rejection is the excess heat from a cooler system. Heat rejection is the total amount of heat energy which is transferred from the cool side to the warm side. All the parts are in the same line therefore it provides the cryocooler with easy operation and it provides high power with less consumption of fuel. The pros of this design are small and low in cost. The con of this design is that it has less power production.



**Figure 25:** Inline regenerative cryocooler

## 5 DESIGN SELECTED –

This chapter discusses the design selection process based on Pugh Chart and Decision Matrix tools as applied to all ten proposed design concepts. Design selection rationale and design description for the first semester design is discussed in sections 5.1 and 5.2 respectively.

### 5.1 Rationale for Design Selection

The following Pugh Chart contributed to the determination of the ten designs selected. Table 9 shows heat transfer, manufacturability, and power input of all the ten different designs. This criterion was made based on the fundamental of thermodynamics and the customer requirements. Based on the criteria, the best three designs will be selected and put into a decision matrix to come up with the final design that the team will be analyzing and re-engineering.

**Table 9** Pugh Chart

|           | Transfers Heat | Manufacturability/Size | Minimizes Seals | Power Input | Sum of + | Sum of - | Sum of S |
|-----------|----------------|------------------------|-----------------|-------------|----------|----------|----------|
| Design 1  | +              | -                      | s               | +           | 2        | 1        | 1        |
| Design 2  | +              | -                      | -               | s           | 1        | 2        | 1        |
| Design 3  | -              | s                      | s               | +           | 1        | 1        | 2        |
| Design 4  | s              | s                      | -               | +           | 1        | 1        | 2        |
| Design 5  | -              | S                      | +               | -           | 1        | 2        | 1        |
| Design 6  | S              | S                      | -               | +           | 1        | 1        | 2        |
| Design 7  | +              | +                      | S               | S           | 2        | 1        | 2        |
| Design 8  | \              | \                      | \               | \           | \        | \        | \        |
| Design 9  | s              | s                      | -               | +           | 1        | 1        | 2        |
| Design 10 | +              | -                      | -               | s           | 1        | 2        | 1        |

In a Stirling cycle the heat transfer and power input are important to figure out the efficiency and the Coefficient of performance of the cycle. Also, the chosen designs (1,2, and 7) were mostly based on the heat transfer, manufacturability, minimizing seals, and the power input of the system.

In the decision matrix below the best three designs were selected from the Pugh chart. Design one (Benchtop Apparatus) was selected to be considered as the best design. Evaluating designs 1, 2 and 7 in the decision matrix led us to the fact that design one's power input and heat transfer is the best, compared to two and seven.

**Table 10** Decision Matrix

|                       |               | Sketch #1        |                | Sketch #2        |                | Sketch #7        |                |
|-----------------------|---------------|------------------|----------------|------------------|----------------|------------------|----------------|
| Criteria (Objectives) | Weight (100%) | Score (Out of 1) | Weighted Score | Score (Out of 1) | Weighted Score | Score (Out of 1) | Weighted Score |
| Transfers Heat        | 35            | 0.75             | 26.25          | 0.75             | 26.25          | 0.75             | 26.25          |
| Cost                  | 25            | 0.5              | 12.5           | 0.25             | 6.25           | 0.75             | 18.75          |
| Power Input           | 25            | 1                | 25             | 0.5              | 12.5           | 0.25             | 6.25           |
| Size                  | 15            | 0.5              | 7.5            | 0.25             | 3.75           | 0.25             | 3.75           |
| Total                 | 100%          |                  | 71.5           |                  | 48.75          |                  | 55             |

## 5.2 Design Description

Design features described herein show attributes that reflect the efforts of decision making tools utilized and explained in the above sections. Benchtop testing is the primary application of an existing Stirling Cryocooler design that will allow variability of sub-system parameters to be changes and experimented within a laboratory setting. This will be accomplished by the manufacture of a scaled-up version of the Twinbird Corporation Stirling Cryocooler. This apparatus will be mounted to a framework that supports the system and grants access to various subsystems to install measurement probes, alternate working fluids, alternate regenerator material cartridge, and adjust motor speed. System control will be accomplished using either the existing motor control circuit board or an appropriately sized variable frequency drive. Sensor probes will concentrate to an Arduino platform that will have display and data logging capabilities.

Motion analysis was conducted on the three subsystems that include compression piston,

displacer, and linear actuating motor revealed a very complex analytical model. The general synchronization between motor speed, which would be the same as piston speed, and the displacer will require more analysis in the future to determine optimal displacer size and fluid cavity. The following analysis summary is taken from the individual analysis focusing on motion dynamics and forces [26].

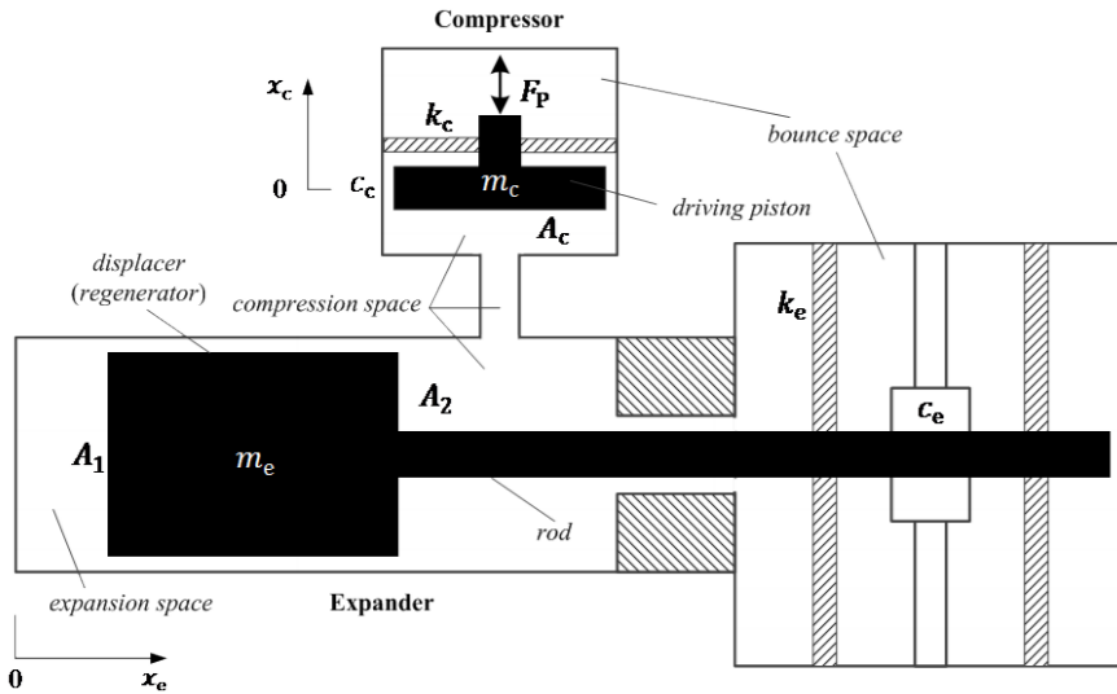
The specified power within the motor was sufficiently analyzed and corresponded to the maximum operating pressures within the working cylinder. Namely, the rated voltage of the push-pull solenoid & the duty cycle was used to derive the average voltage delivered to the motor. With this, the force and by extension, the maximum operating pressure, was deciphered and will be used as a guide for further design changes with respect to the motor.

Free Piston cryocoolers are desirable since they have essentially two moving parts with Sinusoidal movement along shaft with a fixed axis. A fixed piston and a displacer move linearly with the piston but are not connected. The displacer and piston do not oscillate at the same time but rather the piston moves at the same speed as the linear motor speed while the displacer responds to the movement of the working fluid as it shifts from cold to hot areas of the assembly.

To model this motion, an idealized mathematical model proposed by Y X Guo et al attempts to analyze the thermodynamic characteristics and the performance of a FPSC. Elimination of a displacer driving mechanism of a free piston, reduces efficiency due to the displacer damping force necessary to produce cooling. This aspect of the free piston creates unexpected factors that may deviate from predicted amplitudes and phases [27].

Assumptions for mathematical models concerning Stirling engines are similar throughout the literature. Research for this analysis as revealed common assumptions and are listed in Y X Guo et al in-list form [27].

- Working fluid is ideal gas;
- Working fluid pressure throughout system is equal and uniform;
- Working fluid temperature is constant throughout system;
- Regenerator is ideal and contributes no friction loss;
- No leakage or friction occurs in the clearance seals;
- Bounce space pressure remains constant and equal to average pressure;
- Piston and Displacer are in simple harmonic motion, while pressure oscillates in simple harmonic manner; From these assumptions, Figure 26 shows an ideal free-piston Stirling cryocooler that this model and assumptions are based on [1].



**Figure 26.** Idealized free-piston Stirling cryocooler. [1].

**Table 11.** Main variables represented in mathematical model for motion.

| Physics Notation | Explanation                                                           |
|------------------|-----------------------------------------------------------------------|
| $m_e$            | the total mass of the displacer and the rod                           |
| $k_e$            | spring stiffness of the spring that connects to the rod               |
| $c_e$            | damping coefficient of the damper that connects to the rod            |
| $A_1$            | the bottom area of the displacer on the side of the expansion space   |
| $A_2$            | the bottom area of the displacer on the side of the compression space |
| $m_c$            | the mass of the driving piston                                        |
| $k_c$            | spring stiffness of the spring that connects to the driving piston    |
| $c_c$            | drag coefficient of the driving piston                                |
| $A_c$            | the bottom area of the driving piston on both sides                   |

Using measurements kindly provided by AMTEK are attached to this document. These cad drawings provide a general guide to a functional machine that is currently used in industry. Having no physical guide to base theoretical calculations from, estimates of displacer diameter, cylinder diameter, piston diameter and piston displacement can be achieved. From these estimates,  $A_1$ ,  $A_2$ , and  $A_c$  as well as  $m_c$ ,  $m_e$ , can be determined. However, the remaining coefficients of spring stiffness, drag, and damping will also have to be estimated. Results of this calculations will provide an estimate of the amount of force delivered when the given parameters are calculated. This value will contribute to the overall estimate that will determine the effectiveness of the cooling capacity of the Stirling cooler. This rough calculation process once validated by testing, will then be adjusted and compared to an actual Stirling cooler that will be purchased by the design team and analyzed.

Estimated sizes for individual parts are listed in the Bill of Materials located in appendix B. As stated above, actual sizes may be scaled larger to accommodate measurement probe attachment locations and ease of disassembly for interchangeable regenerator material.

## 6 Proposed Design

Implementation of the Stirling Cryocooler design will be performed by further reverse engineering of an existing design. The Envirocooler that was purchased served as a guide to reverse engineer and contribute to this design. The project manufacturing plan is set to cost analysis and time management. The cost analysis is based on the materials that will be used to manufacture the design by either the team or by the machine shop.

Following disassembly of the Twinbird Cryocooler, more detailed inspection allowed the team to create an obtainable design plan. Revisions to the BOM reflect the advancement of design plans following complete disassembly of the Twinbird cooler. CAD models for fabrication have also been revised to reflect actual machining capabilities and limitations of both shop and labor resources.

Manufacturing duties will be performed by the team in the university shop facility (Building 98C). Initial tooling required will include a lathe to precisely shape parts including the displacer, shaft, and piston. Seal housing and attachments will be determined as design continues. Modified CAD drawings (Figure 25 and 26) show dimensions and tolerances of main parts. The potential for linear motor changes are present and design will incorporate an adjustable mounting apparatus that will allow for possible size changes if necessary.

Sourcing costs are detailed in the attached bill of materials located in appendix B. Items listed in the parts and materials were purchased during this semester. Donated and loaned items are also listed in the far-left side of the BOM. These items were borrowed to advance linear motor operation and will be replaced with approved modules of feasible cost. Once a linear motor was delivered, focus on operation in high frequency reciprocating motion was achieved using MODICON process logic control (PLC) and human/machine interface (HMI), made by Redlion. These instruments act as a software storage and motor control interface. Specialized assistance in module selection and operation was given by a professional instrumentation technician, Mr. Rod Liebie, who was a previous co-worker with a member of this team.

Once fabrication of the cryocooler is complete, testing will be conducted by the team. Connection to the currently operating solenoid motor will immediately confirm or deny if force calculations and motor selection are correct. Modifications to this may include, but not be limited to: purchase of more powerful linear motor that delivers higher continuous force, reduction of piston/displacer mass, and reduction of piston/displacer size. Friction reduction may be addressed by adjusting the tolerance requirement of the piston cylinder interface, either by piston size reduction or cylinder reaming.

## 7 Implementation

Design and fabrication efforts have advanced since the complete (and destructive) disassembly of the Twinbird Corporation cryocooler was conducted. This allowed for a thorough investigation and measurement of parts that were previously displayed with arbitrary and grossly simplified geometries. Having the ability to measure and adjust existing design features greatly improved considerations for

manufacturability. Once these observations were made, focus was directed at obtaining the proper training and experience with machining operations that would be required. Initial construction of the display mounting and electrical architecture were executed while the opportunity and scheduling for training was coordinated. Revisions of CAD models were also performed with enhanced measurement and scale considerations included.

## **7.1 Manufacturing**

Construction of the Stirling Cryocooler test apparatus consists of the display base that components required for operation will attach. Design considerations and preliminary sketches allow for low cost material selection and assembly processes to begin. Motor selection and control modules, orientation and attachment of components, and wire routing and architecture were roughly placed on repurposed shelving. This mounting surface is held with right angle brackets that simply join 5/8-inch Unistrut. Adjustability to future design changes is made possible using Unistrut railing and hardware while preserving strength and appearance.

Due to the optimal geometry of this project, fabrication of the Stirling Cryocooler will mostly involve turning stock on a lathe. Individual parts have been simplified and designed to replicate parts of the Twinbird design with modifications that allow for time constraints, manufacturing time and experience, material cost, and customer needs. This team anticipates using the manufacturing lab located on campus in building 98C. Communication with shop managers requesting machining guidance has been initiated.

Resources that have and will contribute to the manufacturing of this device include utilization of the training and availability from the fabrication shop and its managers. Participation in basic and advanced tool safety and machine operation had been obtained by nearly all members of this design team at this time. Initial design features were based on only an exterior view of the Twinbird cryocooler. Now that it has been completely disassembled, more detailed design considerations have been created. Drawings that reflect these changes are attached to this report and will be used for fabrication.

## **7.2 Design Changes**

With respect to design changes, this semester has been anything but shy of additional considerations for the design of a free-piston Stirling Cooler. The initial diameter of the working cylinder was originally specified to be 4.5 inches, was decidedly changed to 3.25 inches due to a number of constraints. Namely, the cost of the aluminum stock as well as the amount of time it would take to ship, was dependent upon the amount of stock ordered. With this in mind, the team decided to scale down the final design. Additionally, it was recently determined in an individual analysis that the pressure applied by the piston could be increased by either increasing the power delivered to the motor or decreasing the cross sectional area of the piston. With these in mind, a reduction in the size of the cylinder diameter was justified.

The control of the motor being used in this design was decidedly changed from Arduino to a more robust, motor control instrumentation system. Namely the PLC motor controller, the Human Machine Interface and the I/O module will be used in place of Arduino to control parameters like frequency, stroke length and power delivered. This design decision was made to ensure the manufacturing portion of the project would have an appropriate amount of time allocated to it. In the case that the motor control instrumentation cannot be kept, per the City of Flagstaff's discretion, an affordable replacement system will serve to function in the same state as that of the current system. The programming and electrical considerations beyond the specializations within the team, will be outsourced to Mr. Rod Liebie. Additionally, the team will fall back on Arduino if the current motor control system cannot be permanently kept and/or replaced. A metal oxide semiconductor field effect transistor in this case, would be used to regulate the duty cycle. An additional capacitor would be specified in this circuit, to correspond to the appropriate frequency.

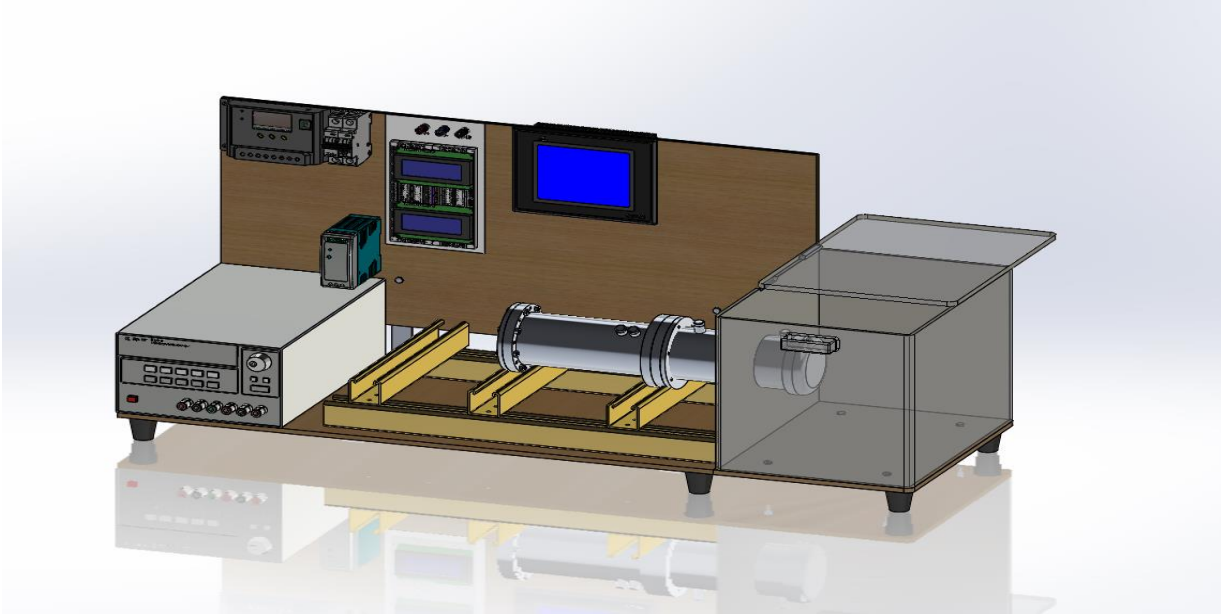
The heatsink attached to the cold head of the main cylinder, which is on the side closest to the motor, was modified in the final design. The heat fins in the final design were designed in a way to simplify the manufacturing process. Namely, the heat sink shown in Figure 28 below, is directly attached to the main cylinder, meaning that heat sink will be turned with a mechanical lathe and will be contained within the “cylinder” part of the assembly. This will not only simplify the manufacturing necessary to complete this project, but it will also spare the team more time for the data collection portion of the project. Additionally, it is well known that if the heat sink was made a separate part from the cylinder, small micro-voids contained between the annular heat sink and the cylinder will introduce inherent inefficiencies due to contact resistance. Namely, the aforementioned micro-voids are filled with air, which is highly resistive to heat transfer. By making the fin assembly and cylinder one piece, the effect of contact resistance is effectively eliminated.

As is described in previous sections within this report, the cold head of the Stirling Cooler will be oriented in the overall system in a manner that allows for heat transfer from the cooler space, all the way to the heat sink, to the atmosphere. Namely, the cold head will be contained within the top of a cooler with an attached heat sink. This heat sink will serve increase the effective wetted area, which increases the amount of heat that can be transferred across the cold head. Additionally, a fan will also be integrated into the final system (within the cooler) to increase the effective Reynold’s number and thereby increasing the heat transfer. The purpose of the heat sink being contained at the top of the cooler is based on how free convection functions. Namely, it is well known that in low velocity flow, particles with high thermal energy will rise in elevation, while those with lower relative thermal energy will fall. This phenomenon is the basis for placing the cold head at the top of the cooler. The placement of the cold head at the top also creates the largest possible temperature difference, which is directly related to the associated heat transfer.

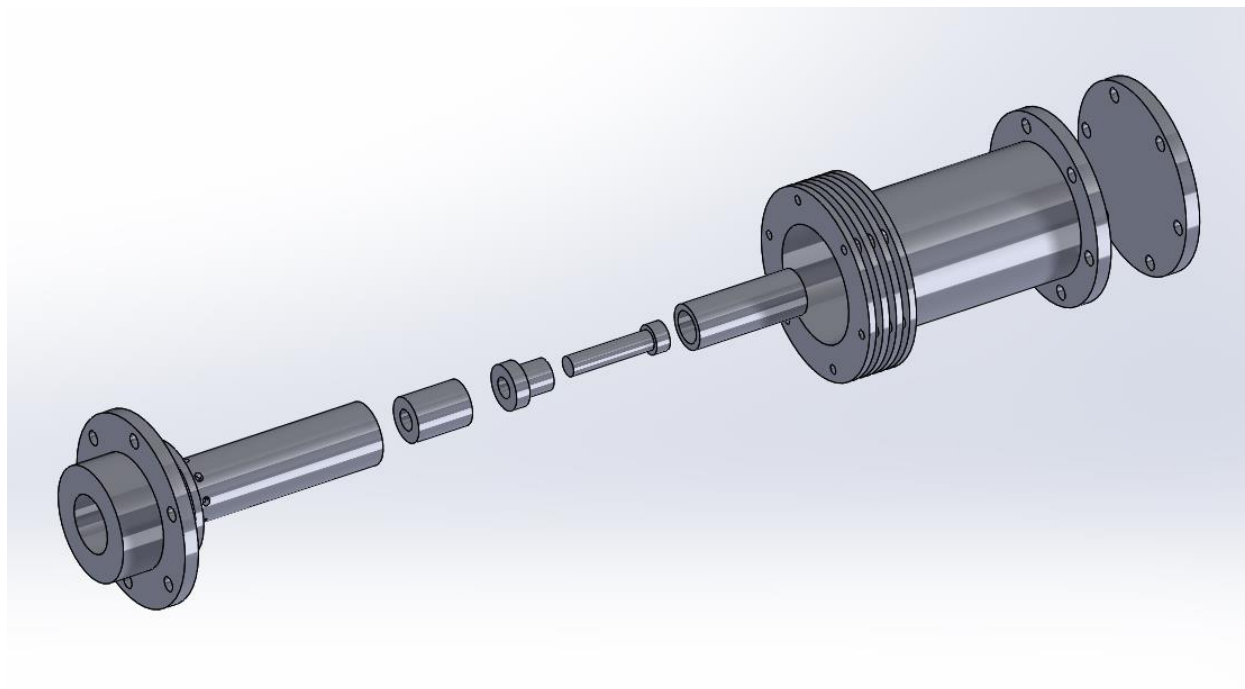
Per the technical analysis provided in the appendix (A-C), the solenoid purchased for the final design will not allow for a maximum operating pressure of 2.5 MPa, as was specified in the TwinBird Stirling Cooler that was analyzed previously. A new motor for the final design will be considered and potentially purchased depending on the functionality of the final product and the discretion of our client, Dr. Trevas. A motor shaft adaptor will be designed onto the piston to allow for the replacement of the motor in the case that the motor needs to be replaced for one with a higher power/force rating. Additionally, this adaptor will also serve to increase the manipulability of the final design, when the design is being used and/or fixed.

Finally, the I/O module included in the motor control instrumentation system allows for many different attachments to be used with the system. The Modicon thermocouple module will be used here to record temperatures in different components of the design. The Arduino thermocouples will also be used in the final design when the programming has been finalized and design has been fabricated.





**Figure 27: New Assembly CAD**



**Figure 28** Updated assembly of cold head, heat exchanger, and inner piston/displacer.

## References

- [1] G. R. O. F. G. Walker and E. Bingham, "The Stirling alternative," *Gordon and Breach Science*

- Publishers*, 1994.
- [2] W. D. Haag, "Gamma-Stirling," Darmstadt Und Handwärmestirling, [Online]. Available: [www.w-haag.de/stirlingmotor.htm](http://www.w-haag.de/stirlingmotor.htm).
  - [3] I. Urieli, "Beta Type Stirling Engines," Ohio State University, 30 12 2011. [Online]. Available: <https://www.ohio.edu/mechanical/stirling/>. [Accessed 28 June 2018].
  - [4] "SGC-4000HG: Stirling Gas Cooler - Apex Instruments," Apex Instruments, 2018. [Online]. Available: <http://www.apexinst.com/product/sgc-4000hg>. [Accessed 2018 June 2018].
  - [5] "Stirling Cooler Model: SC-TD08. 2018".
  - [6] E. Loktionov, A. Martirosyan and M. Shcherbina, "Solar Powered Free-Piston Stirling – Linear Alternator Module for the Lunar Base," 2018.
  - [7] C. Song, J. Lu and Y. Kitamura, "Study on the COP of free piston Stirling cooler (FPSC) in the anti-sublimation CO<sub>2</sub> capture process," *Renewable Energy*, vol. 74, pp. 948-954, 2015.
  - [8] I. Urieli, "Chapter 3b - The First Law - Closed Systems - Stirling Engines," Ohio State University, 5 July 2018. [Online]. Available: [https://www.ohio.edu/mechanical/thermo/Intro/Chapt.1\\_6/Chapter3b.html](https://www.ohio.edu/mechanical/thermo/Intro/Chapt.1_6/Chapter3b.html). [Accessed 24 June 2018].
  - [9] "GLOBAL Accessory for Shuttle ULT-25N Ultra-Low Temperature Freezers, Stirling Ultracold # ULT25EXT ( 10027-524 ) - Model ULT-25N One-Year Warranty, Each," Careforde Scientific, 2018. [Online].
  - [10] "Stirling Cooler Model: SC-TD08," Twinbird Corporation, 2018. [Online]. Available: [http://file:///C:/Users/johnTwiley/Desktop/Free%20Piston/manual\\_SC-TD08.pdf](http://file:///C:/Users/johnTwiley/Desktop/Free%20Piston/manual_SC-TD08.pdf). [Accessed 24 June 2018].
  - [11] C. West, "Principles and applications of Stirling engines," *Van Nostrand Reinhold*, 1986.
  - [12] J. W. L. Köhler, "The Stirling Refrigeration Cycle," *Scientific American*, vol. 212, no. 4, p. 119–127, 1965.
  - [13] P. Bertsch, "CLEARANCE SEALS AND PISTON FOR CRYOGENEC REFRGERATOR COMPRESSORS," 1986.
  - [14] E. Sugahara, "PISTON ROD SEALING ARRANGEMENT FOR A STIRLING ENGINE," 6 June 1978.
  - [15] A. Caughley, A. Tucker, M. Gschwendtner and M. Sellier, "Novel diaphragm based Stirling cryocooler," *American Institute of Physics*, p. 667–674, 2012.
  - [16] T. L. Bergman, A. S. Lavine, F. P. Incropera and D. P. Dewitt, *Fundamentals of heat and mass transfer*, New York: John Wiley & Sons, 2011..
  - [17] "Stirling engine," Wikipedia, 2018. [Online]. Available: [https://en.wikipedia.org/wiki/Stirling\\_engine](https://en.wikipedia.org/wiki/Stirling_engine). [Accessed 27 June 2018].
  - [18] "Modeling Linear Motors or Generators in COMSOL Multiphysics," COMSOL Multiphysics©, 2018. [Online]. Available: <https://www.comsol.com/blogs/modeling-linear-motors-or-generators-in-comsol-multiphysics/>. [Accessed 27 June 2018].
  - [19] A. Boroujerdi and M. Esmaili, "Characterization of the frictional losses and heat transfer of oscillatory viscous flow through wire-mesh regenerators," *Alexandria Engineering Journal*, vol. 54, no. 4, p. 787–794, June 2015.
  - [20] T. R. Knowles, "Composite Matrix Regenerator for Stirling Engines," *NASA*, 1997.
  - [21] Q. Zhou, L. Chen, C. Pan, Y. Zhou and J. Wang, "Experimental Investigation on Regenerator Materials of Stirling-type Pulse-tube Refrigerator Working at 20K," *Physics Procedia*, vol. 67, p. 530–535, 2015.

- [22] M. Tanaka, I. Yamashita and F. Chisaka, "Flow and Heat Transfer Characteristics of the Stirling Engine Regenerator in an Oscillating Flow," *JSME International Journal*, vol. 33, no. 2, pp. 283-289, 1990.
- [23] M. Dietrich, L. Yang and G. Thummes, "High-power Stirling-type pulse tube cryocooler: Observation and reduction of regenerator temperature-inhomogeneities," *Cryogenics*, vol. 47, no. 5-6, p. 306–314, March 2007.
- [26] Wiley, J (2018) Individual Analysis Report, unpublished document. Northern Arizona University.
- [27] Y. Guo, Y. Chao, Z. Gan, S. Li and B. Wang, "Performance analysis on free-piston Stirling cryocooler based on an idealized mathematical model", *IOP Conference Series: Materials Science and Engineering*, vol. 278, p. 012174, 2017.

## Appendix A: Additional Designs Considered.

In this concept design a building shape system has piston, compressor, and it has a displacer on one side. When the piston will move the displacer will get the compression and expansion from the tube. There is a regenerator and displacer working together in this system to produce the power. The pros of this design are high power production, fuel efficient, less energy consumption, and high generation, and the con is high cost.

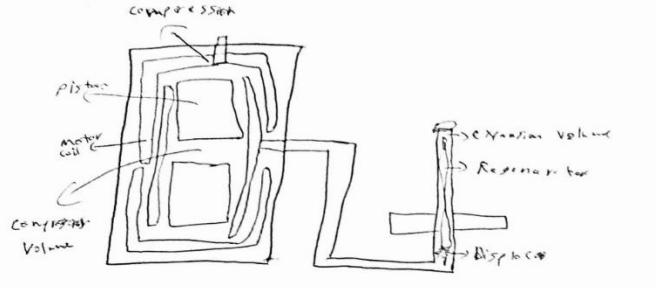


Figure 29: Top line Cryocooler

## Design #5: Hut form cryocooler

The design is showing below in which a hut form system is showing with one piston and two compressor volumes. The advantage of this design is that it has the piston at top with the displacer connected directly with the piston through the tube. So, the power can easily generate in this design without utilizing high energy. The pros of this design are high power, efficient, and piston connects with displacer directly, and the cons are high cost, and larger in size.

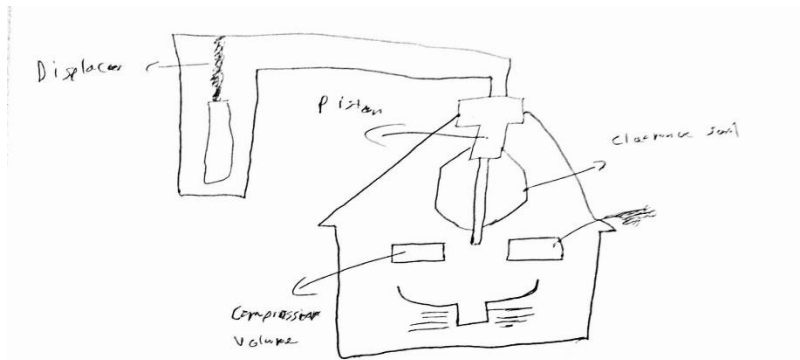


Figure 30: Hut form cryocooler

## Design #6: Alpha-shaped cryocooler

There is one piston and displacer connected directly to each other. The flywheel moves the piston and that piston produce the compression in between the displacer. The design is showing below, which has the flywheel to produce the expansion and compression like the alpha engine. The pros of this design are high power, and efficient energy consumption and production. The con of this design is high cost.

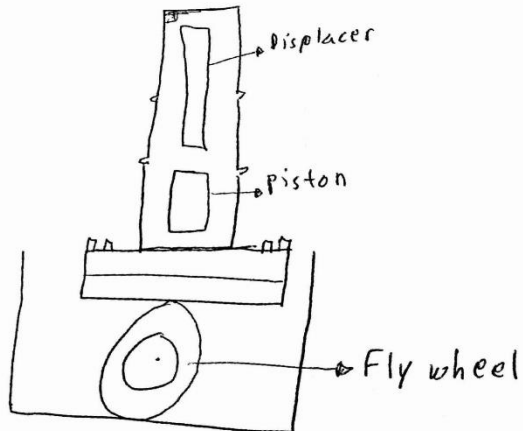


Figure 31: Alpha shaped cryocooler

### 7.3 Design #8: Active cryocooler

In this design concept, the idea is to use the flywheel to move the piston, with the double side heat sink. In this idea, displacer has placed above the piston and the flywheel has connected with both the displacer and piston for rotating both at the same time. The concept is showing below. The pro of this design is highly efficient, and the cons are less power, and high cost.

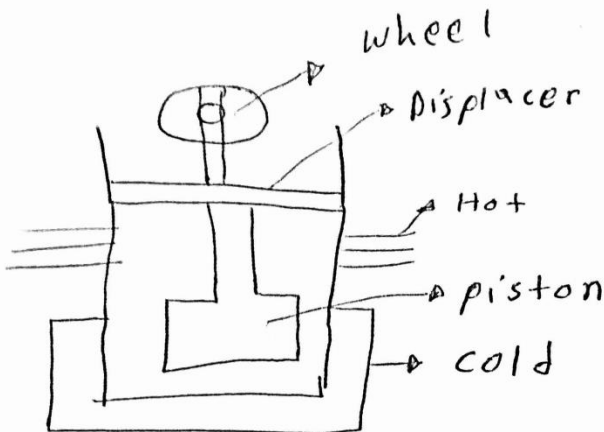


Figure 32. Active Cryocooler

#### 7.4 Design #9: Double Regenerated Cooler

This design is a variation of the alpha configuration. This design uses two regenerators instead of one to maximize the heat conserved by the cycle. This design also uses a flywheel, which is connected to a motor, to induce motion of the pistons. The disadvantages of this design are that a second regenerator introduces another source for heat dissipation. Another disadvantage would be that fact that it would add more to the cost of the device and more work in the analysis of the system.

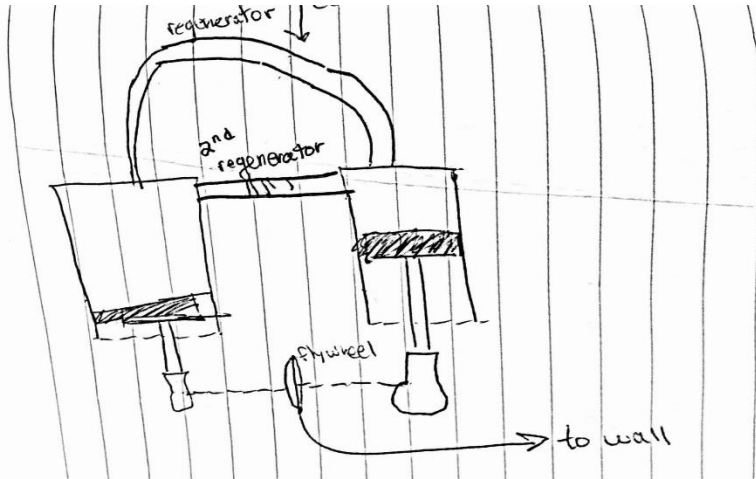


Figure 33: Design 9

#### 7.5 Design #10: Water Cooled Compressor Cooler

This design is a variation of the beta configuration. Namely, it uses a linear motor to mechanically induce motion of the displacer and piston. This design uses stainless steel wire mesh for the regenerator material and has pipe surrounding the compression space that is constantly running with water, to remove more heat. The advantage of this design would be that the heat is being dissipated from the compressor at a faster rate, which would implicate less power consumption. The disadvantage of this design would be that more power would be inherently required to power the water pump.

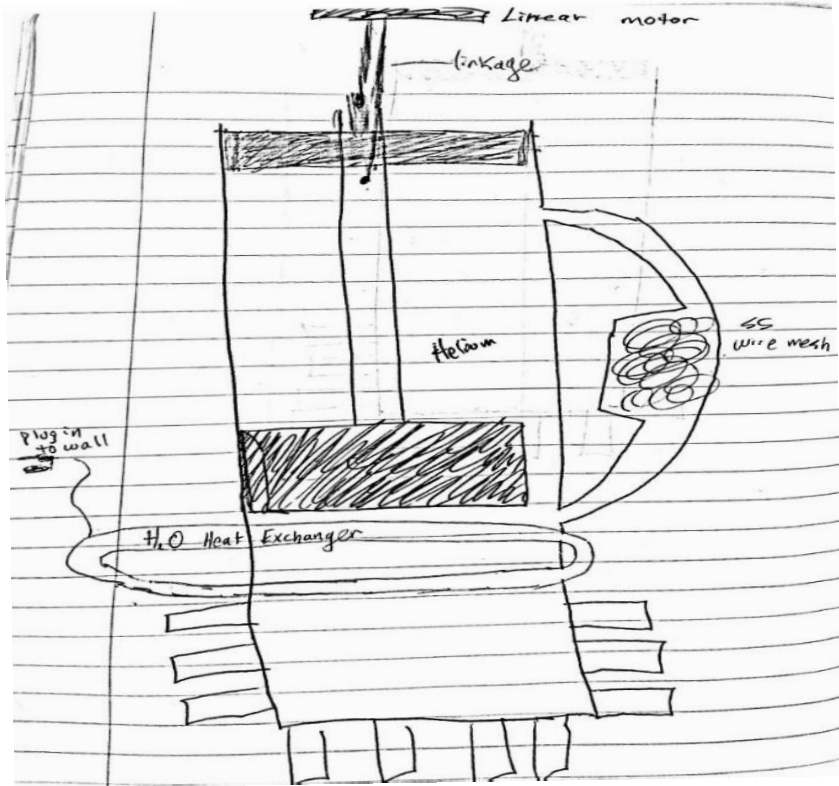


Figure 34: Design 10

## Appendix B: Bill of Materials.

| STIRLING CRYOCOOLER BILL OF MATERIALS |        |                                                            |      |                                              |                          |               |              |                  |
|---------------------------------------|--------|------------------------------------------------------------|------|----------------------------------------------|--------------------------|---------------|--------------|------------------|
|                                       | PART # | PART NAME                                                  | QTY. | DESCRIPTION                                  | MATERIAL                 | COST/UNIT(\$) | SOURCE       | ACTUAL COST (\$) |
| R & D                                 | 1      | Envirocooler ActiVault 25L4C Cooler -12V                   | 1    | Existing Design/Reverse Engineering          | N/A                      | 377.25        | Ebay         | 377.25           |
|                                       | 2      | Schumacher PC-6 120AC to 6A 12V DC Power Converter         | 1    | 12 V VoltageE Converter                      | N/A                      | 16.53         | Amazon       | 16.53            |
|                                       | 3      | Module + K Type Thermocouple Temperature Sensor            | 4    | Arduino Thermocouple Sensors                 | Steel Braided            | 6.99          | Amazon       | 27.96            |
|                                       | 4      | Elegoo EL-KIT-008 Mega 2560                                | 1    | Arduino Starter Kit                          | Misc. Electronics        | 59.99         | Amazon       | 59.99            |
|                                       | 5      | Adafruit MicroSD card breakout board+ [ADA254]             | 1    | Arduino Datalogger                           | Misc. Electronics        | 9.16          | Amazon       | 9.16             |
|                                       | 6      | SanDisk Mobile Class4 MicroSDHC Flash Memory Card          | 1    | Flash Memory Card                            | N/A                      | 6.95          | Amazon       | 6.95             |
|                                       | 7      | Programming Arduino: Getting Started with Sketches 2nd Ed. | 1    | Arduino Programming Book                     | Paperback                | 10.20         | Amazon       | 10.2             |
|                                       | 8      | ELEGOO Upgraded 37 in 1 Sensor Modules Kit                 | 1    | Arduino Extra Sensor Kit                     | Misc. Electronics        | 29.86         | Amazon       | 29.86            |
| PARTS AND MATERIALS                   | 9      | Black Laminated Wood Shelving                              | 2    | Used To Support Instrumentation              | Laminated Particleboard  | 9.98          | HomeDepot    | 19.96            |
|                                       | 10     | 2-Hole 90 degree angle bracket                             | 10   | Used To Join Unistrut Frame                  | Steel                    | 14.10         | HomeDepot    | 14.1             |
|                                       | 11     | UniStrut Spring Nuts                                       | 5    | 5 pc/unit Springnut for joining Unistrut     | Steel                    | 5.00          | HomeDepot    | 25.00            |
|                                       | 12     | Unistrut Bracing                                           | 1    | Structural Frame for Display Mounting        | Steel                    | 15.00         | HomeDepot    | 15.00            |
|                                       | 13     | Bolts                                                      | 50   | Box of 1/4" x 1" coarse thread               | Steel                    | 15.00         | HomeDepot    | 15.00            |
|                                       | 14     | Pull Push Type Linear Motion Solenoid Electromagnet        | 2    | uxcell XRN-25x50TL DC 24V 0.7A 17W 20N 10mm  | Steel                    | 19.97         | Amazon       | 39.94            |
|                                       | 15     | Aluminum Material for fabrication                          | 4    | 3-1/2" x 8" solid aluminum stock             | Aluminum                 | 38.89         | Stoner Metal | 155.56           |
|                                       | 16     |                                                            |      |                                              |                          |               |              |                  |
|                                       | 17     |                                                            |      |                                              |                          |               |              |                  |
| DONATED ITEMS                         | 18     | 40 W, Single Output, 24 V @1.7A AC-DC Power Supply         | 1    | Mean Well MDR-40-24                          | Plastic Case/Electronics | 17.10         | On-line      | 0                |
|                                       | 19     | Touch Scree, KADET 2, Model G307K2                         | 1    | RedLion Human Machine Interface (HMI)        | Touchscreen/Electronics  | 833.40        | redLion      | 0                |
|                                       | 20     | BMXCPS2000 Modicon X80 PowerSupply                         | 1    | Power Supply for Process Logic Control (PLC) | Plastic Case/Electronics | 140.71        | Ebay         | 0                |
|                                       | 21     | BMX-P34-100 Processor Module                               | 1    | Schneider Elect. Main PLC motor controller   | Plastic Case/Electronics | 878.00        | Ebay         | 0                |
|                                       | 22     | 4-Slot Backplane                                           | 1    | Schneider Elect. BMXXBP0400                  | Stainless/Electronics    | 211.00        | Ebay         | 0                |
|                                       | 23     | DIN Rail                                                   | 1    | Small Lengths approx. (2Feet)                | Stainless                | 6.55          | Ebay         | 0                |
|                                       | 24     | DIN Rail Terminal Block,                                   | 5    | 30 A/ 600V 30-10 AWG terminal block          | Plastic                  | 2.50          | On-line      | 0                |
|                                       | 25     |                                                            |      |                                              | Donated Value            | 2089.26       | Actual Cost  | 822.46           |



## Appendix C: Matlab Code for Motor & Magnet Analysis

```
clc;
clear all;
%% Design based specifications
f = 60; %Hertz - frequency of the solenoid motion
Dc = .5; % percentage - duty cycle
Ap = pi*.25*(.0206375^2); %m^2 - piston area (D = 13/16")
%% Solenoid characteristics
Ps = 17; %Watts - Specified Power of the Solenoid
Vs = 24; %Volts - rated voltage of solenoid
m = 2; %kilograms - max rated pull force
m1 = 8 + m; %kilograms - weight of shafts, piston and displacer apparatus attached to solenoid.
Ls = .03175; %meters - length of the stroke (1.25")
T = 1/f; %seconds - how much time the power is on and off per cycle
U = 2*Ls*f; %m/s - velocity of the solenoid
Vrms = Vs*sqrt(Dc); %root mean squared voltage for the pulsating square wave
Rmsr = 30; %ohms - measured resistance across the solenoid
Imsr = .2; %amps - measured
Irms = Vrms/Rmsr; %amps - current based on a power of 13 Watts specified by solenoid
Prms = (Vrms^2)/Rmsr; %Watts - Power associated with the rms
Fs_ideal = Ps/(2*Ls*f); %Newtons - max pull force of the solenoid (Force = power/velocity)
%Solenoid force associated with a power delivery of 13 Watts
%(derived from the solenoid specifications)
Fs_rms = Prms/(2*Ls*f); %%Newtons - max pull force of the solenoid (Force = power/velocity)
acc = Fs_rms/m; %m/s^2 - max acceleration of solenoid (as determined by the rms values)
acc1 = Fs_rms/m1; %m/s^2 - acceleration determined by accounting for all weight acting on solenoid
Pmax = Fs_rms/Ap; %Pascals - max pressure within the cylinder at any time
%% PWM Allocation Calculation
Rds = .012; %ohms - Drain to Source resistance; from IRF3708 MOSFET data sheet
Rth = 62; %K/W - thermal resistance of the MOSFET junction; from IRF3708 MOSFET data sheet
Imax = .7;
Pl = (Imax^2)*Rds; %Watts - max thermal power dissipation
deltaT = Rth*Pl; %Kelvin - change in temperature caused by solenoid's current
%% Magnet Force
Dm = .0127; %m - diameter of internal displacer magnet (1.5"); R842
Lm = .0015875; %length of the displacer magnet; R842
mu0 = 4*pi*10^(-7); %N/A^2 - permeability of free space
%R841 Neodymium Magnet - .5"O.D., .25"I.D. & t=.0625"
Volid = ((.0625)*pi*.25*((.5^2) - (.25^2)))/61023.744; %m^3 - volume of magnet w/in displacer
Brid = 1.32; %tesla - internal displacer magnet Residual Flux Density
mid = (1/mu0)*Brid*Volid; %A.m^2 - magnetic dipole moment of internal displacer
%R841 Neodymium Magnets - .5"O.D., .25"I.D. & t=.0625"
```

```

Brw = Brw; %%tesla - wall magnet(s) Residual Flux Density
Volw = ((.0625)*pi*.25*((.5^2) - (.25^2)))/61023.744; %m^3 - volume of wall magnet(s)
mw = (1/mu0)*Brw*Volw; %A.m^2 - magnetic dipole moment of the magnets' on either wall
abc = (Ls-Lm)/2; %stroke minus displacer shell length
r = linspace(0,abc,100); %distance vector (between magnets)
r(1,1) = NaN; %to get rid of the infinity term
F = -(3*mu0*mid*mw)*(2*pi.*r.^4).^(-1); %force between two magnets as a function of distance
r1 = linspace(abc,2*abc,100);
F1 = -(3*mu0*mid*mw)*(2*pi.*r1.^4).^(-1); %force between two magnets as a function of distance
F_tot = F-F1;
F_tot = abs(F_tot);
F1 = abs(F1);
F = abs(F);
F_tot = [F_tot fliplr(F_tot)];
r2 = linspace(0,2*abc,200);
figure(1)
subplot(2,2,1)
plot(r,F)
title('Force Vs Distance (b/w Closest Magnets)')
xlabel('Distance b/w Closest Magnets (Meters)')
ylabel('Force (Newtons)')
subplot(2,2,2)
plot(r1,F1)
title('Force Vs Distance (b/w Furthest Magnets)')
xlabel('Distance b/w Furthest Magnets (Meters)')
ylabel('Force (Newtons)')
subplot(2,2,3)
plot(r2,F_tot)
title('Resultant Force Vs Distance b/w Closest Magnets')
xlabel('Distance b/w Closest Magnets (Meters)')
ylabel('Force (Newtons)')

```