



Go Baby Go-D

Sponsor/Client: Dr. Sarah Oman

Presented by: Hussien Alajmy, Saleh Almasari, Shahah Eshkanani, Yousef Alraqem, Yousef Alenezi

Project Description

- Aims in helping Disabled children.
- Make children feel normal.
- Help build a better prototype for the child in need.



Figure 1: GBG [1]

Design

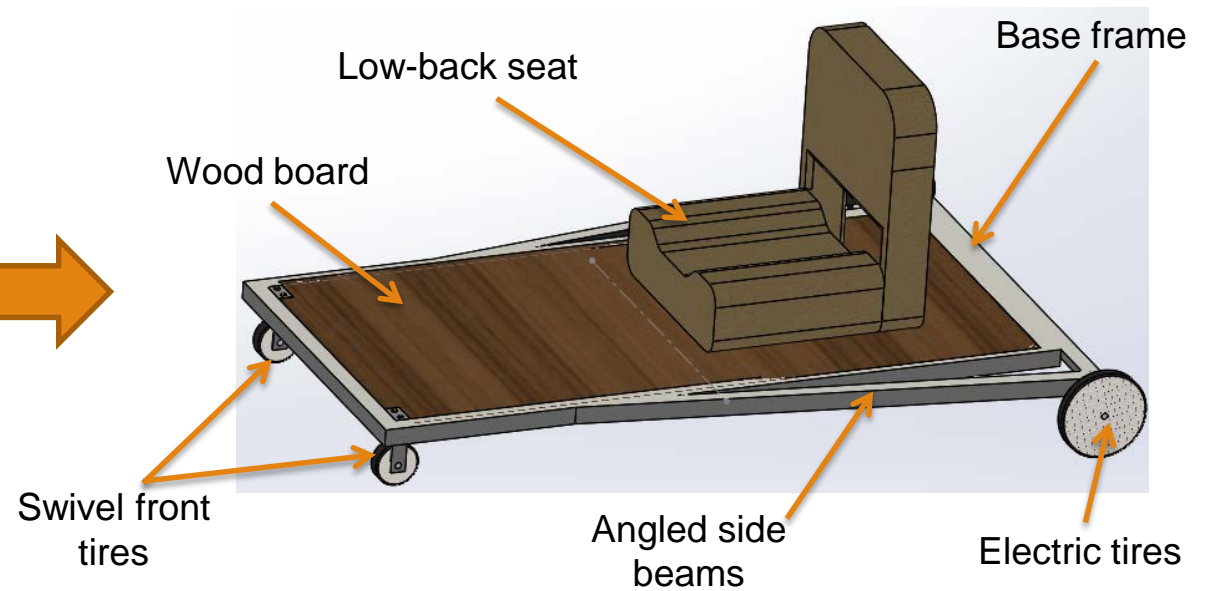
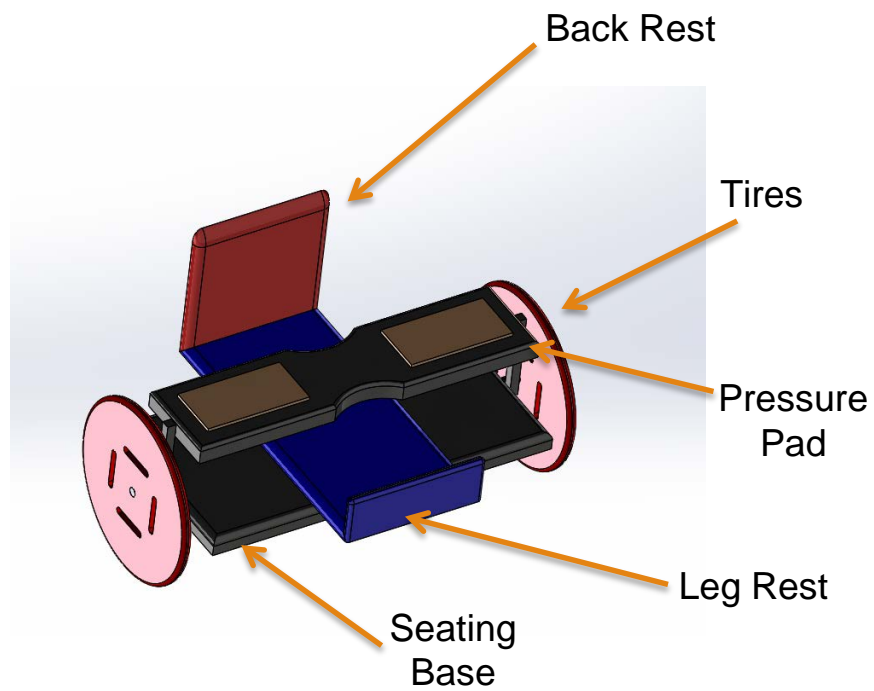

Figure 2: Capstone part 1 final PPT CAD design

Figure 3: Current CAD design

Updates

❖ Design Changes:

- Since last presentation instead of making the base from scratch the team ordered a ready base (low-back seat)

❖ Reasons:

- Allow more space for other parts
- Lower electrical hazard risk = more safety
- User weight compatibility
- More balance is required

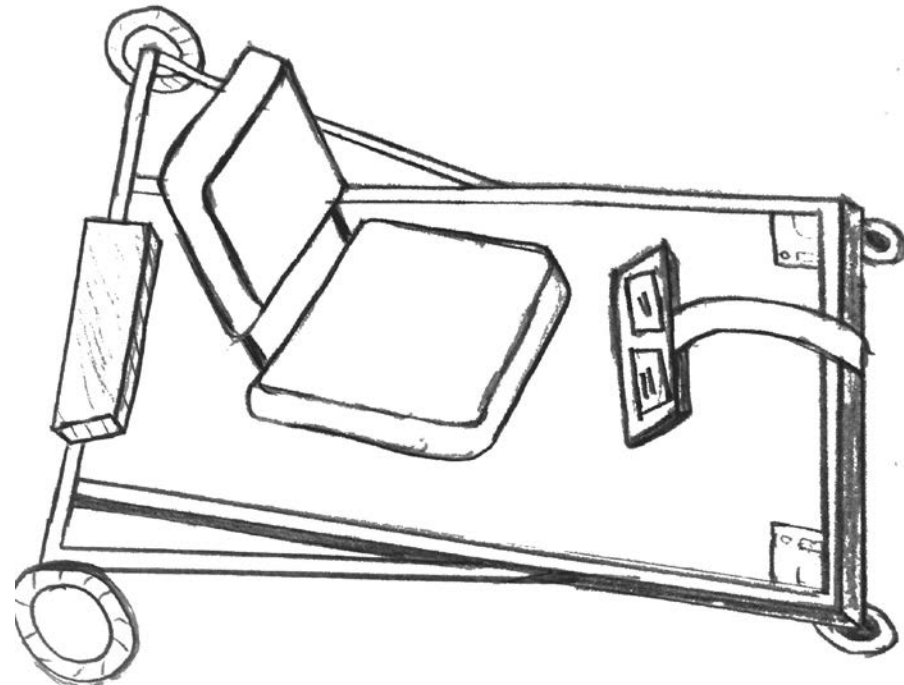

Figure 4: Current design sketch

Manufacturing

- **Base frame**
- **Wooden board to the frame**
- **Swivel front tires**
- **Low back seat**
- **Angled side beams (Balance)**

Figure 5: Current Manufactured Design

Manufacturing

- Changed rear tire location for balance + safety
- Balance all electric tires on one level using U bolts
- Electric circuit board + Wiring system



Figure 7: Electric board + wiring



Figure 6: U bolts

DOE

- **Batteries:**
 - Check the amount of power needed to operate the device
 - Avoid electrical hazard
- **Alignments:**
 - Check if the device can move straight
 - Avoid jerking motion
- **Weight:**
 - Check approximate weight compatibility
 - Device portability

Manufacturing Plan

☐ Hardware 1 (Accomplished):

- Electric scoot base
- Swivel + Electric Tires

☐ Hardware 2:

- Electronic wiring
- Batteries
- Pressure Pad
- Leg rest
- Aesthetics

Testing

- ❑ Weight compatibility: Test the maximum weight
- ❑ Electrical circuits: Test the power supply + Circuits
- ❑ Pressure pads: Applying different amounts of hand pressure
- ❑ Heat generation: Test different durations while the device is on
- ❑ Balance check: Operate the device by swerving sharply and instant changes in acceleration

Responsibilities

















Table 1: Team members responsibilities and skills

Name	Responsibility	Testing Responsibility
Hussen Alajmy	Safety, welding	Weight compatibility
Saleh Almasari	Welding	Heat generation
Shahah Eshkanani	Electronics	Electrical circuits
Yousef Alraqem	Interior design	Pressure pads
Yousef Alenezi	Alignments	Balance check

***All team members are attending all testing sessions**

Budget

Table 2: Bill of Materials [27-43]

Parts	Image	Market	Price
Toolkit 550 Piece Metric Sheet Metal Screw Assortment - Contains 13 Popular Sizes [27] Option-B		Amazon	\$5.99
BAA SHOP Two Wheels Mini Smart Self Balancing Scooter (Adapter) [28]		Amazon	\$10.99
D@Boards Replacement Rubber Parts for 2 wheel self balance scooter hoverboard [29]		Amazon	\$15.00
Go-Ped Stealth II Hoverboard Electric Scooter Battery Set[30]		BatterySharks	\$39.96
RocketBus Replacement 6.5" Inch Power Motor Wheel for Self-Balance Smart Scooter IO Hawk PhunkeeDuck Swagway Hoverboard [31]		Amazon	\$139.94
VIIVRIA® 9 in 1 Balance Scooter Circuit Repair Kit Board Main Hover Board replacement parts 2 Wheel 6.5"[32]		Amazon	\$69.99
Lap Seat Belt, Chrome Lift Latch, 60 Inch Length [33]		Amazon	\$14.64
K'NEX Combat Crew 5-in-1 Building Set [34]		Amazon	\$31.80
MDF Panel (Common: 3/4 in. x 4 ft. x 8 ft.; Actual: 0.750 in. x 48 in. x 96 in.) [35]		The Home Depot	\$35.66
Minger Car LED Strip Light,4pcs DC 12V Multi-color Car Interior Music Light LED Underdash Lighting Kit with Sound Active Function and Wireless Remote Control, Included Car Charger [36]		Amazon	\$20.99
Wise Economy Low Back Seat [37]		Amazon	\$33.89
SOLOOP 480Pcs 12 Size Assorted Insulated Electrical Wiring Wire Terminal Crimp Connector Kit Butt Spade Set [38]		Amazon	\$20.98
Caster Set (2 Swivel/2 Locking) [39]		Global Industrial	\$33.89
Wire Rope Clip, U-Bolt, 1/2In, Forged Steel*4 [40]		ZORO	\$49.63
48 in. x 1-1/4 in. x 1/16 in. Plain Steel Square Tube [41]		Home depot	\$17.66
4 x (1-1/2 in. x 36 in. Plain Steel Angle with 1/8 in. Thick [9] [42]		The Home Depot	\$37.88
SENSOR BRACKETS FOR SENSOR BOARDS *2 COUNT [43]		Hoverboard Repair	\$22.77

Total Cost \$601.66

Gantt Chart

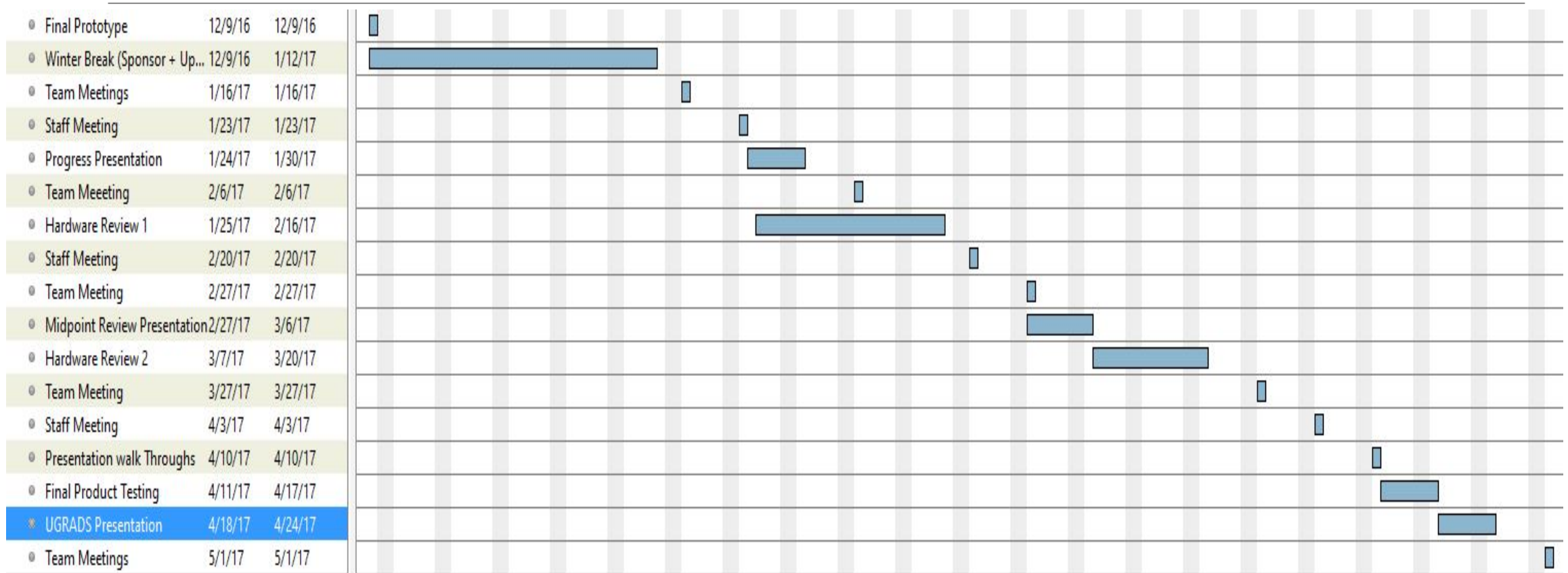

Figure 7: Gantt Chart

References:

[27] Amazon, "Toolkit 550 piece metric sheet metal screw assortment - contains 13 popular sizes," in Amazon.com: All, Amazon, 1996. [Online]. Available: https://www.amazon.com/Toolkit-Piece-Metric-Sheet-Assortment/dp/B014HWUHJA/ref=sr_1_3?ie=UTF8&qid=1481650698&sr=8-3&keywords=metal+screws. Accessed: Dec. 13, 2016.

[28] Amazon, "BAA SHOP Two wheels Mini smart self balancing scooter (adapter)," in Amazon.com: All, Amazon, 1996. [Online]. Available: https://www.amazon.com/Wheels-Smart-Balancing-Scooter-Adapter/dp/B014F6I60K/ref=sr_1_1?ie=UTF8&qid=1479861025&sr=8-1&keywords=BAA+SHOP+Two+Wheels+Mini+Smart+Self+Balancing+Scooter+%28Adapter%29%5B. Accessed: Nov. 23, 2016

[29] Amazon, "D@Boards replacement rubber parts for 2 wheel self balance scooter hoverboard," in Amazon.com: All, Amazon, 1996. [Online]. Available: https://www.amazon.com/Boards-Replacement-balance-scooter-hoverboard/dp/B019J5PPJC/ref=sr_1_1?ie=UTF8&qid=1479861084&sr=8-1&keywords=D%40Boards+Replacement+Rubber+Parts+for+2+wheel+self+balance+scooter+hoverboard%5B. Accessed: Nov. 23, 2016.

[30] "Stealth II Hoverboard Go-Ped electric scooter battery set (4 batteries - 6V 12Ah)," www.batterysnarks.com. [Online]. Available: http://www.batterysnarks.com/Go-Ped-Stealth-II-Hoverboard-p/StIIHboard_ups6-12_x4.htm?gclid=CLGct4H3hdICFRBxfgodm_AO4w. Accessed: Mar. 2, 2017.

[31] Amazon, "RocketBus replacement 6.5" inch power motor wheel for self-balance smart scooter IO hawk PhunkeeDuck Swagway Hoverboard," in Amazon.com: Sports & Outdoors, Amazon, 1996. [Online]. Available: https://www.amazon.com/RocketBus-Replacement-Self-Balance-PhunkeeDuck-Hoverboard/dp/B01AAOLHX4/ref=pd_rhf_se_s_cp_31?_encoding=UTF8&psc=1&refRID=28KE9G3YDEK5GDJ47E23. Accessed: Nov. 23, 2016

[32] Amazon, "VIIVRIA® 9 in 1 balance scooter circuit repair kit board main hover board replacement parts 2 wheel 6.5," in Amazon.com: Sports & Outdoors, Amazon, 1996. [Online]. Available: https://www.amazon.com/VIIVRIA-Balance-Scooter-Circuit-replacement/dp/B01A5ETBL4/ref=pd_rhf_se_s_cp_15?_encoding=UTF8&psc=1&refRID=P87VRG40BP3T3CHNP9AV. Accessed: Nov. 23, 2016.

[33] Amazon, "2-Point lap seat belt, black, 60 inch length, with chrome lift latch," in Amazon.com: All, Amazon, 1996. [Online]. Available: https://www.amazon.com/2-Point-Black-Length-Chrome-Latch/dp/B0013HW9IK/ref=sr_1_1?ie=UTF8&qid=1479861469&sr=8-1&keywords=Lap+Seat+Belt%2C+Chrome+Lift+Latch%2C+60+Inch+Length. Accessed: Nov. 23, 2016.

[34] Amazon, "K'NEX combat crew 5-in-1 building set," in Amazon.com: All, Amazon, 1996. [Online]. Available: https://www.amazon.com/KNEX-Combat-Crew-Building-Set/dp/B00RZV5UJ8/ref=sr_1_1?ie=UTF8&qid=1479861514&sr=8-1&keywords=K%27NEX+Combat+Crew+5-in-1+Building+Set. Accessed: Nov. 23, 2016.

[35] H. D. P. Authority, "1-1/2 in. X 36 in. Plain steel angle with 1/8 in. Thick-801497 - the home depot," The Home Depot, 2000. [Online]. Available: <http://www.homedepot.com/p/1-1-2-in-x-36-in-Plain-Steel-Angle-with-1-8-in-Thick-801497/204225768>. Accessed: Dec. 13, 2016.

[36] "MDF Panel (Common: 3/4 in. x 4 ft. x 8 ft.; Actual: 0.750 in. x 48 in. x 96 in.)M11161249097000000A - The Home Depot", The Home Depot, 2017. [Online]. Available: <http://www.homedepot.com/p/MDF-Panel-Common-3-4-in-x-4-ft-x-8-ft-Actual-0-750-in-x-48-in-x-96-in-M11161249097000000A/202332600>. [Accessed: 30- Jan- 2017].

References:

[37]"Amazon.com: Minger Car LED Strip Light,4pcs DC 12V Multi-color Car Interior Music Light LED Underdash Lighting Kit with Sound Active Function and Wireless Remote Control, Included Car Charger: Sports & Outdoors", Amazon.com, 2017. [Online]. Available: https://www.amazon.com/Minger-Multi-color-Interior-Underdash-Lighting/dp/B01M5D9WV2/ref=sr_1_1?s=sporting-goods&ie=UTF8&qid=1485813417&sr=8-1&keywords=minger+car+LED+strip+light+4pcs+dc+12v. [Accessed: 30- Jan- 2017].

[38]"Amazon.com : Wise Economy Low Back Seat (Grey) : Boat Seats : Sports & Outdoors", Amazon.com, 2017. [Online]. Available: https://www.amazon.com/Wise-Economy-Back-Seat-Grey/dp/B000AUA6YA/ref=sr_1_1?ie=UTF8&qid=1485813733&sr=8-1&keywords=wise%2Beconomy%2Blow%2Bback%2Bseat&th=1. [Accessed: 30- Jan- 2017].

[39]"Amazon.com: SOLOOP 480Pcs 12 Size Assorted Insulated Electrical Wiring Wire Terminal Crimp Connector Kit Butt Spade Set: Home Improvement", Amazon.com, 2017. [Online]. Available: https://www.amazon.com/SOLOOP-Assorted-Insulated-Electrical-Connector/dp/B00H1O0WOM/ref=sr_1_1?ie=UTF8&qid=1485813683&sr=8-1&keywords=soloop+480Pcs+12+size. [Accessed: 30- Jan- 2017].

[40]C. Locking), "Caster Set (2 Swivel/2 Locking)", Global Industrial, 2017. [Online]. Available: <http://www.globalindustrial.com/p/storage/bins-totes-containers/bulk/caster-set-4-swivel-2-locking>. [Accessed: 30- Jan- 2017].

[41]W. R. Clip, U-Bolt, and F. Steel, "Value brand wire rope clip, u-bolt, 1/2In, forged steel 153452," 2011. [Online]. Available: <https://www.zoro.com/value-brand-wire-rope-clip-u-bolt-12in-forged-steel-153452/i/G3475516/?q=wire+rope+clip+u-bolt%2C1%2F2in%2Cforged+steel>. Accessed: Mar. 2, 2017.

[42] Asked, "Everbilt 48 in. X 1-1/4 in. X 1/16 in. Plain steel square tube-801297 - the home depot," The Home Depot, 2016. [Online]. Available: http://www.homedepot.com/p/Everbilt-48-in-x-1-1-4-in-x-1-16-in-Plain-Steel-Square-Tube-801297/204325636?cm_mmc=hd_email_-_Ready_for_pickup_-_20170213_PP_ET_Merch_Ready_for_pickup_3003875_-_product_image__W571355712. Accessed: Mar. 2, 2017.

[43] H. E. LLC and A. R. Reserved, "Sensor brackets for sensor boards *2 count*," 2017. [Online]. Available: <https://hoverboardrepair.com/products/sensor-brackets?variant=19203972422>. Accessed: Mar. 2, 2017.

Thank You

